

Theoretical approaches for nanoscale thermoelectric phenomena



Giuliano Benenti

Center for Nonlinear and Complex Systems,
Univ. Insubria, Como, Italy
INFN, Milano, Italy

Physics Reports 694 (2017) 1–124



ELSEVIER

Contents lists available at [ScienceDirect](#)

Physics Reports

journal homepage: www.elsevier.com/locate/physrep



Fundamental aspects of steady-state conversion of heat to work at the nanoscale

Giuliano Benenti ^{a,b,*}, Giulio Casati ^{a,c}, Keiji Saito ^d, Robert S. Whitney ^e



Outline

- 1) Thermoelectricity in the **quantum coherent regime**
(scattering theory, Landauer formula, energy filtering)
- 2) Thermoelectricity in the **Coulomb blockade regime**
(quantum dot model, kinetic equations)
- 3) Aspects of thermoelectricity in **strongly interacting systems**
(phase transitions, power-efficiency trade-off, power-efficiency-fluctuations trade-off)

Volta and the discovery of thermoelectricity

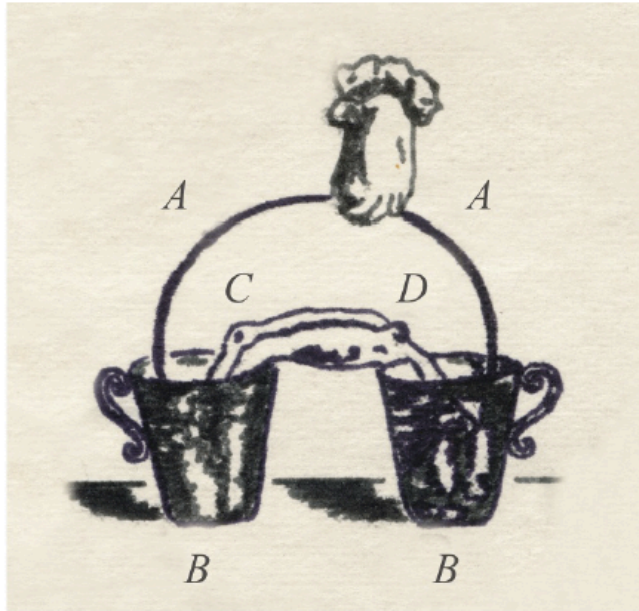

(see Anatychuk et al, “On the discovery of thermoelectricity by A. Volta”)

Fig. 3 Schematic of Volta's experiment that resulted in the discovery of thermoelectricity: A – metal (iron) arc; B – glasses with water; C and D – frog parts placed in the glasses with water.

1794-1795: letters from Volta to Vassali. *“I immersed for some half-minute the end of such (iron) arc into boiling water and, without letting it to cool down, returned to experiments with two glasses of cold water. And it was then that the frog in water started contracting...”*

Traditional versus quantum thermoelectrics

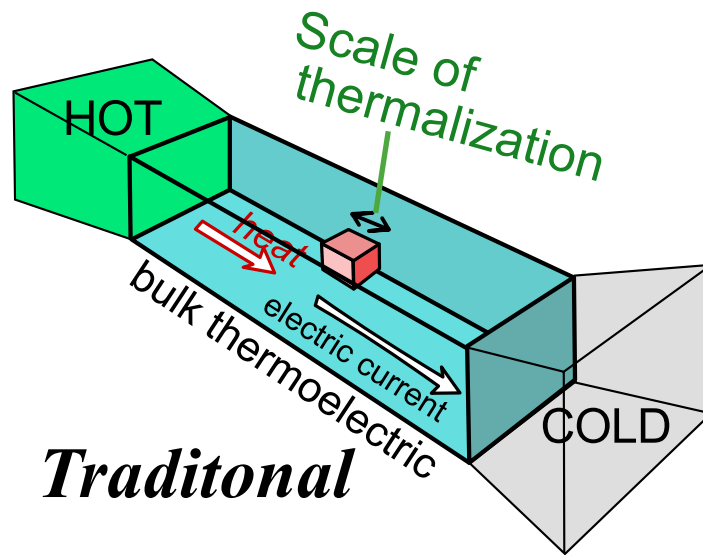

Traditional

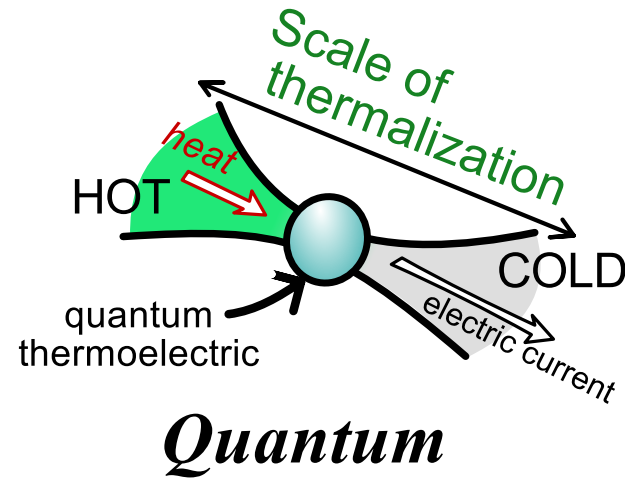

Quantum

Relaxation length (tens of nanometers at room temperature) of the order of the mean free path; inelastic scattering (phonons) thermalizes the electrons

Structures smaller than the relaxation length (many microns at low temperature); quantum interference effects; Boltzmann transport theory cannot be applied; efficiency depends on geometry and size

[see G. B., G. Casati, K. Saito, R. S. Whitney, Phys. Rep. **694**, 1 (2017)]

Traditional thermocouple

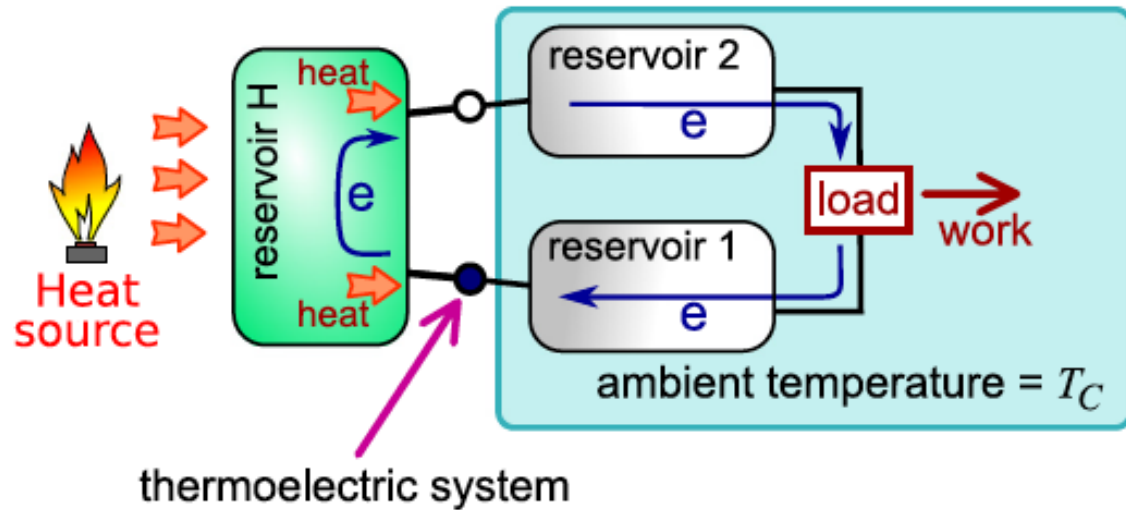

Quantum thermocouple

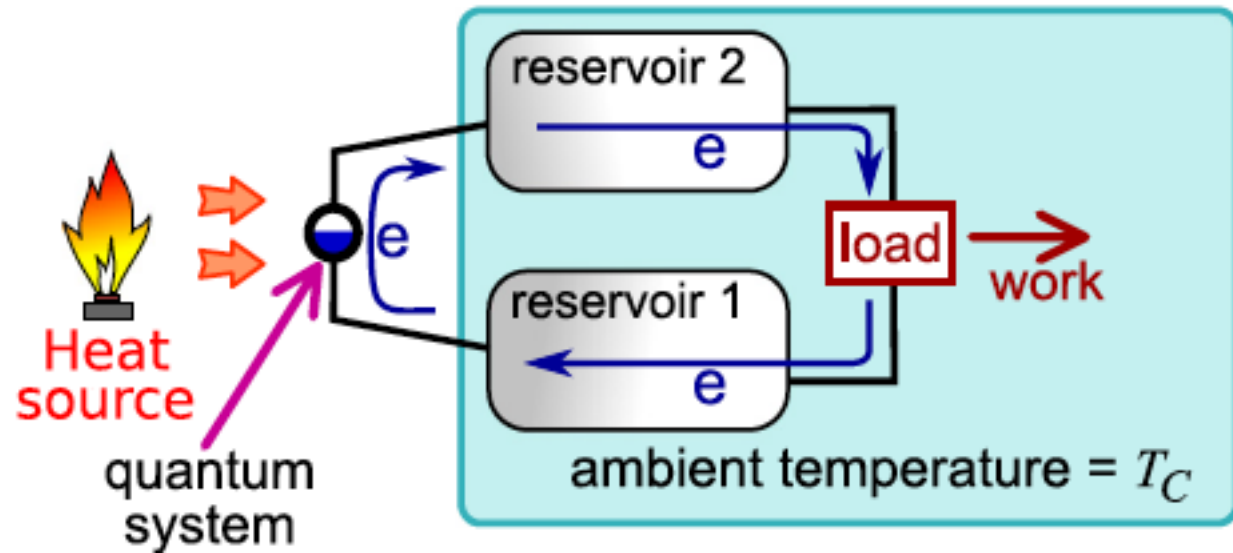

**Noninteracting systems,
Energy filtering,
Landauer scattering theory**

This contribution is part of a special series of Inaugural Articles by members of the National Academy of Sciences elected on April 25, 1995.

The best thermoelectric

G. D. MAHAN*[†] AND J. O. SOFO[‡]

ABSTRACT What electronic structure provides the largest figure of merit for thermoelectric materials? To answer that question, we write the electrical conductivity, thermopower, and thermal conductivity as integrals of a single function, the transport distribution. Then we derive the mathematical function for the transport distribution, which gives the largest figure of merit. A delta-shaped transport distribution is found to maximize the thermoelectric properties. This result indicates that a narrow distribution of the energy of the electrons participating in the transport process is needed for maximum thermoelectric efficiency. Some possible realizations of this idea are discussed.

Heat-to-work conversion through energy filtering

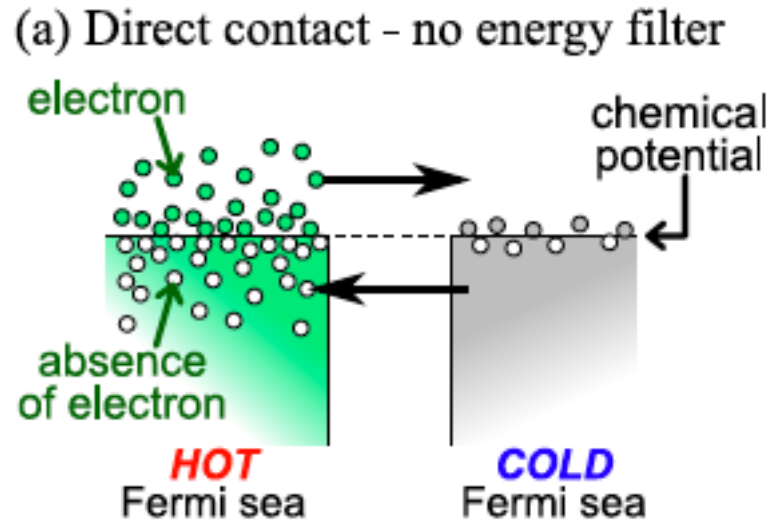

Flow of heat from hot to cold but no flow of charge

(b) Energy-filter as heat-engine

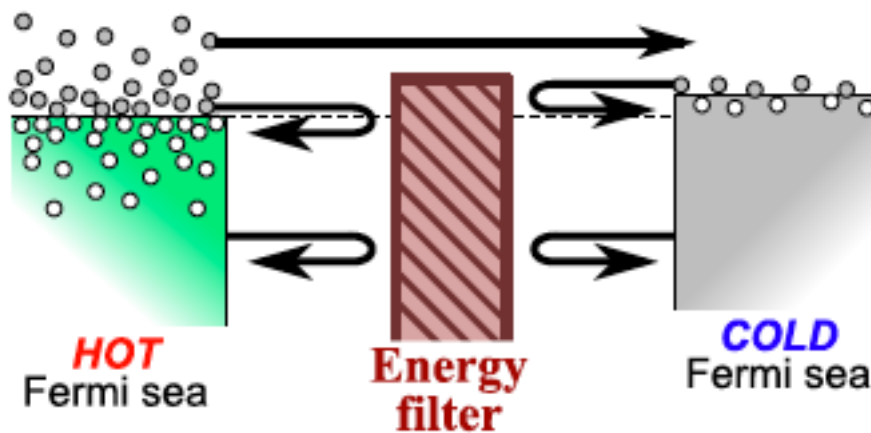

(c) Energy-filter as refrigerator

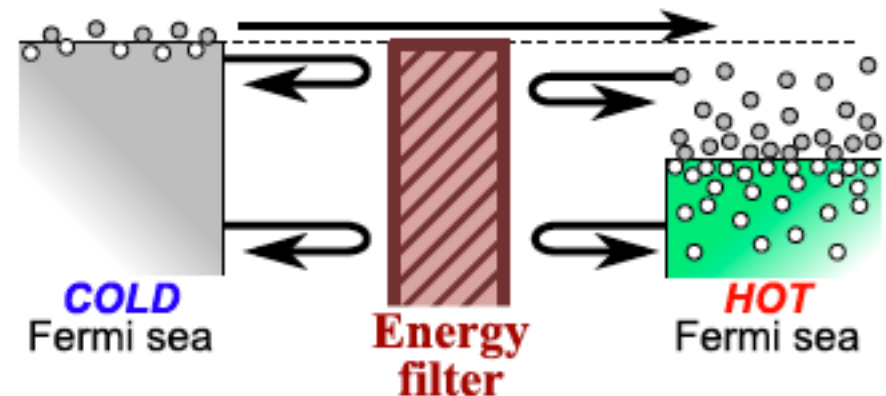

[see G. B., G. Casati, K. Saito, R. S. Whitney, Phys. Rep. **694**, 1 (2017)]

Energy filters in a thermocouple geometry

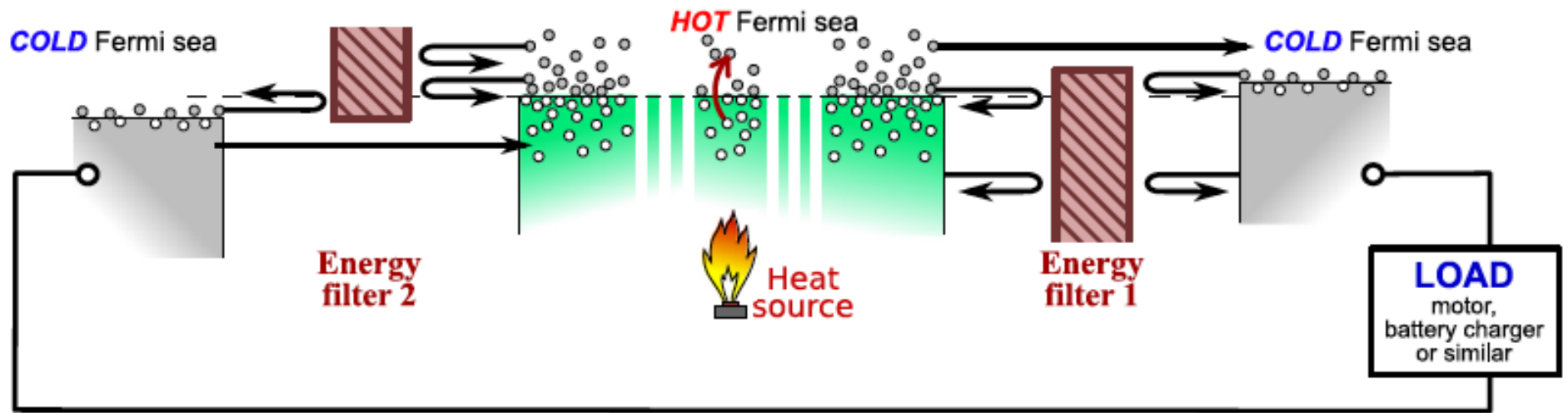

(a) Thermocouple (pair of thermoelectrics) as heat-engine.

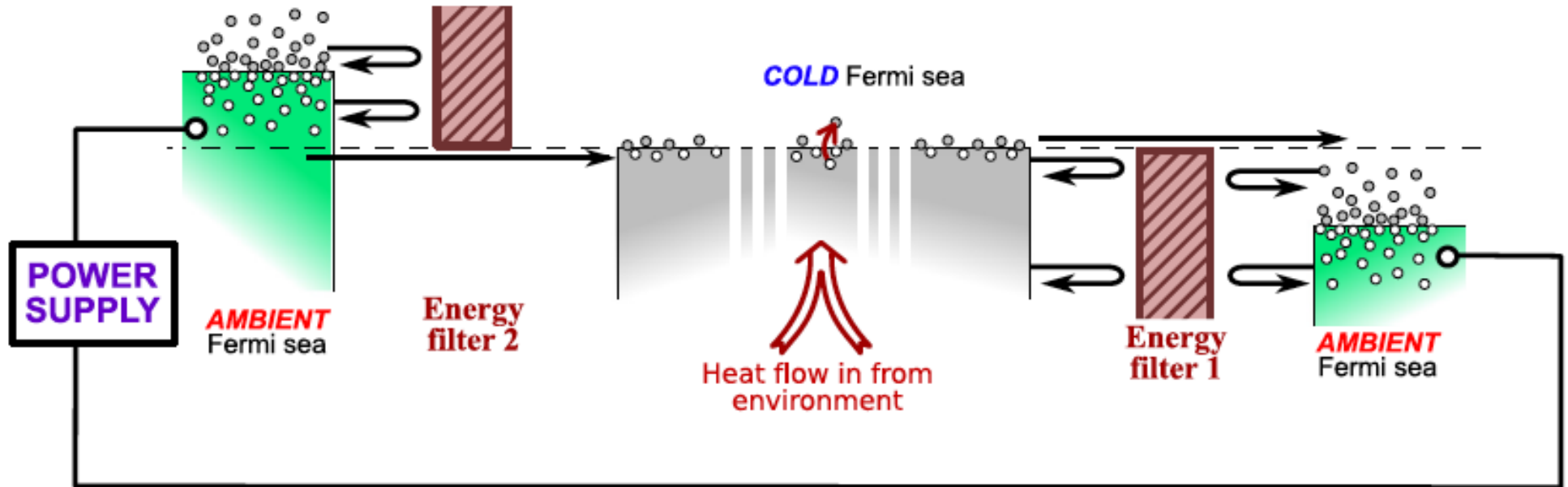

(b) Thermocouple (pair of thermoelectrics) as refrigerator.

What about phonons?

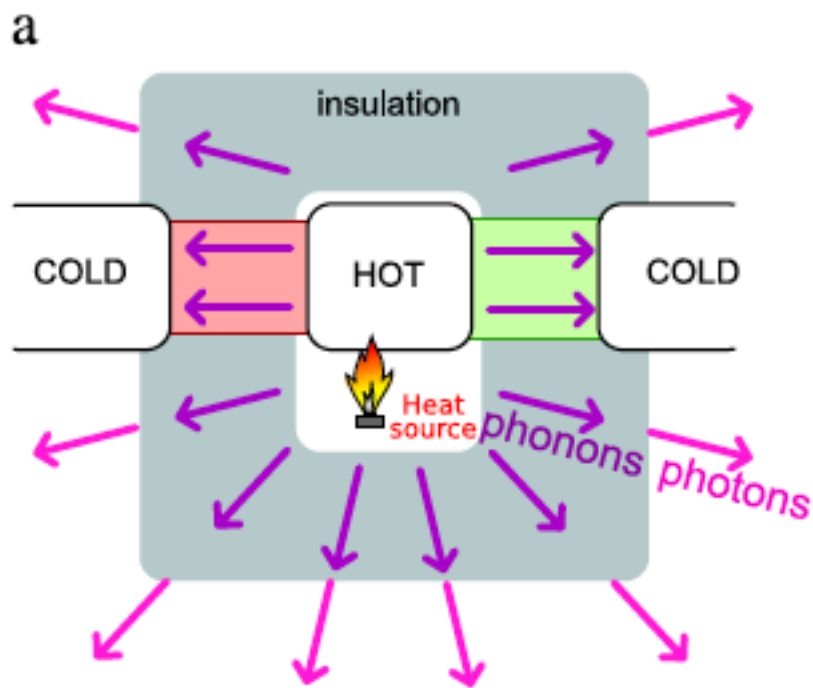

$$\eta_{\text{eng}} = \frac{P_{\text{gen}}}{J_{h,H}^{(\text{el})} + J_{h,H}^{(\text{ph})}}$$

$$\eta_{\text{eng}} \leq \eta_{\text{eng}}^{\text{Carnot}} \times \frac{J_H^{(\text{el})}}{J_H^{(\text{el})} + J_H^{(\text{ph})}}$$

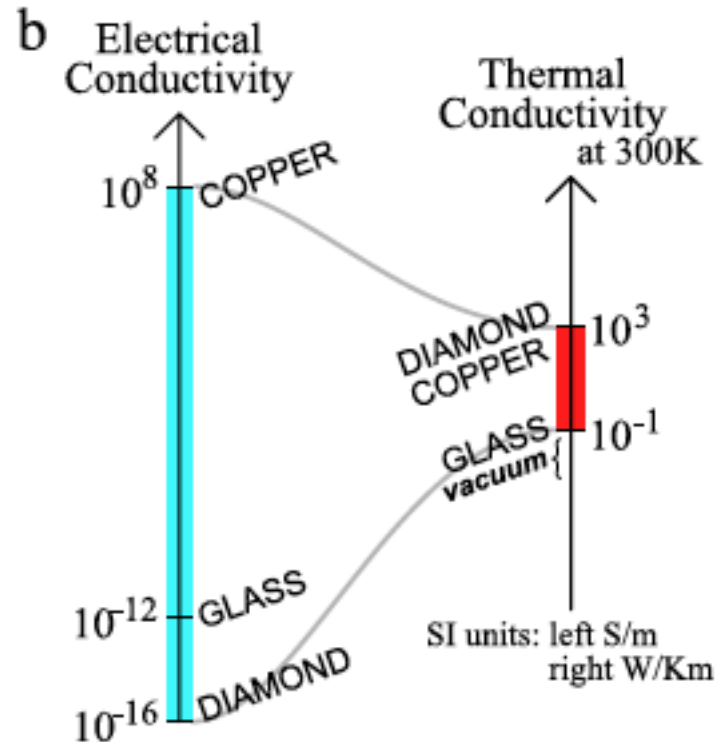

Necessary both: (i) to reduce phonon transport; (ii) to have an efficient working fluid (optimize the electron dynamics)

Reducing thermal conductance

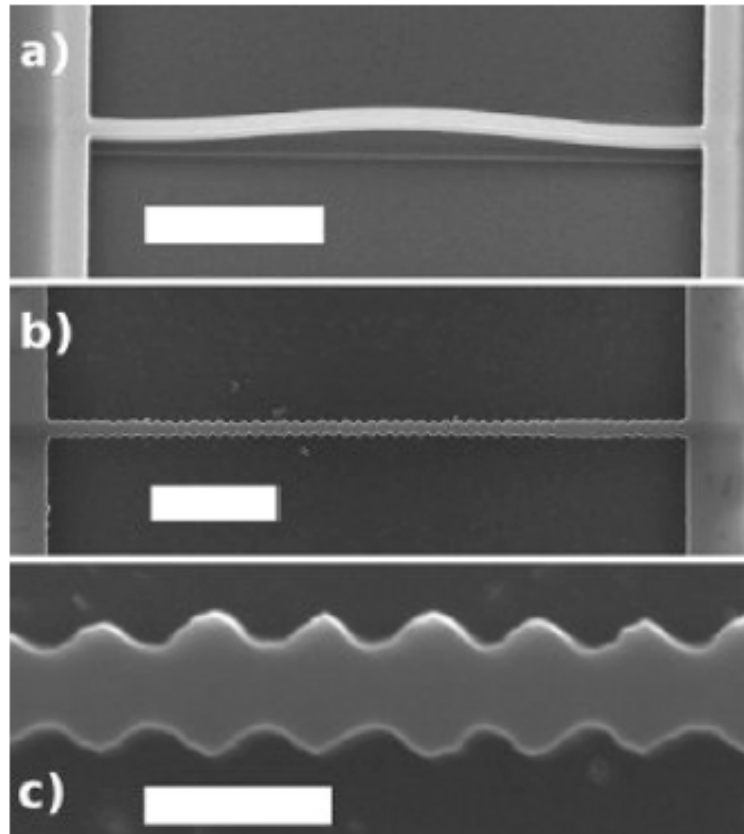

FIG. 1. SEM images of the straight (a) and the corrugated (b) nanowires; (c) corresponds to the top view of the corrugated nanowire. The scale bars correspond to (a) $2\ \mu\text{m}$, (b) $2\ \mu\text{m}$, and (c) $300\ \text{nm}$.

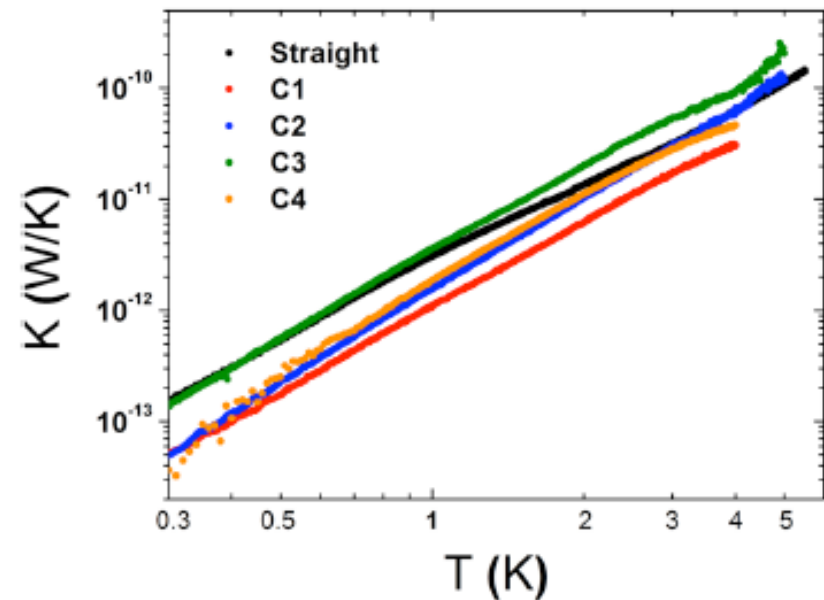
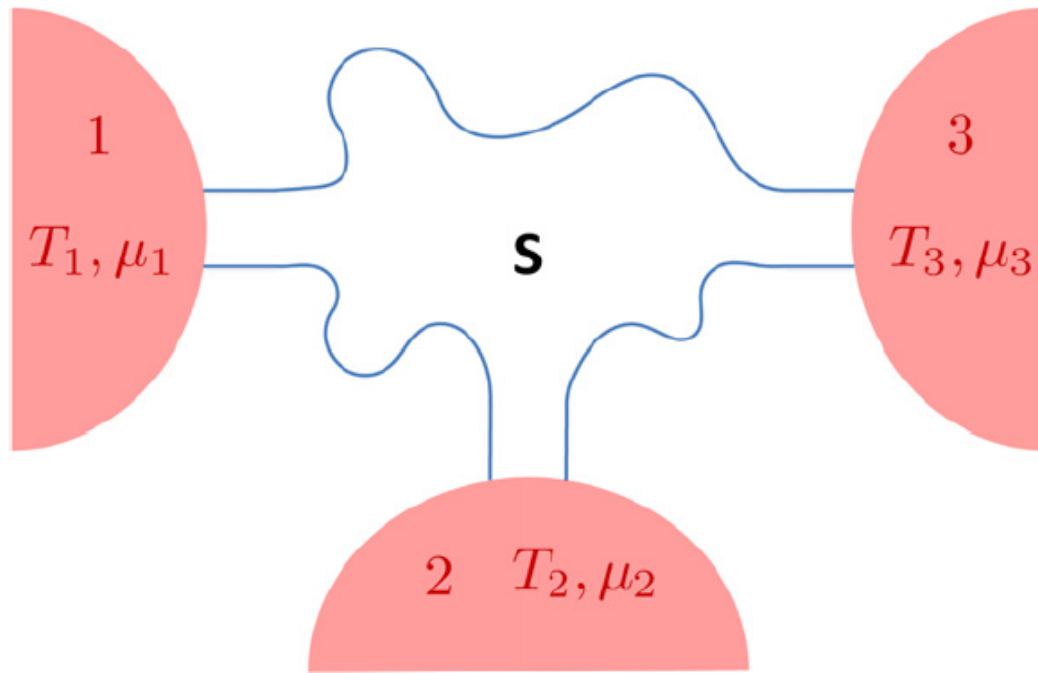

FIG. 2. Thermal conductance versus temperature for a straight nanowire and four corrugated nanowires in the log-log scale.

[Blanc, Rajabpour, Volz, Fournier, Bourgeois, APL **103**, 043109 (2013)]

Scattering theory



Scattering region
connected to
N terminals (reservoirs)

Describes **elastic scattering** (including the effect of a disorder potential), but not electron-electron interactions beyond Hartree approximation and electron-phonon interactions

Transmission matrix

Probability for an electron with energy E to go from (transverse) mode m of reservoir j to mode n of reservoir i :

$$P_{in;jm}(E) = |S_{in;jm}(E)|^2 \quad S_{in;jm}(E) \text{ scattering matrix elements}$$

$$\mathcal{T}_{ij}(E) = \sum_{nm} P_{in;jm}(E) \quad \text{transmission matrix elements}$$

probabilities

$$\mathcal{T}_{ij}(E) \geq 0 \quad \text{for all } i, j, E$$

From conservation of current and condition of zero current at zero bias:

$$\sum_i \mathcal{T}_{ij}(E) = N_j(E), \quad \sum_j \mathcal{T}_{ij}(E) = N_i(E)$$

From time reversal symmetry of the scatterer Hamiltonian:

$$S_{in;jm}(E, -\mathbf{B}) = S_{jm;in}^*(E, \mathbf{B}), \quad \mathcal{T}_{ij}(E, \mathbf{B}) = \mathcal{T}_{ji}(E, -\mathbf{B})$$

Landauer approach

Electrical current into the scatterer from reservoir i:

$$J_{e,i} = \sum_j \int_{-\infty}^{\infty} \frac{dE}{h} e [N_i(E) \delta_{ij} - \mathcal{T}_{ij}(E)] f_j(E)$$

Fermi function $f_i(E) = (1 + \exp[(E - \mu_i)/(k_B T_i)])^{-1}$, $\mu_i = eV_i$

Energy current into the scatterer from reservoir i:

$$J_{u,i} = \sum_j \int_{-\infty}^{\infty} \frac{dE}{h} E [N_i(E) \delta_{ij} - \mathcal{T}_{ij}(E)] f_j(E)$$

$\Delta Q_i = E - \mu_i$ heat carried by an electron leaving reservoir i

Heat current: $J_{h,i} = \sum_j \int_{-\infty}^{\infty} \frac{dE}{h} (E - \mu_i) [N_i(E) \delta_{ij} - \mathcal{T}_{ij}(E)] f_j(E)$.

Kirchhoff's law of current conservation for electrical and energy currents:

$$\sum_i J_{e,i} = \sum_i J_{u,i} = 0$$

Heat current not conserved:

$$J_{h,i} = J_{u,i} - V_i J_{e,i}, \quad \sum_i J_{h,i} = - \sum_i V_i J_{e,i} \quad P_{\text{gen}} = - \sum_i V_i J_{e,i}$$

Heat dissipated in the reservoirs: entropy production rate

$$\dot{\mathcal{S}} = - \sum_i J_{h,i}/T_i$$

Two-terminal (thermoelectric) power production

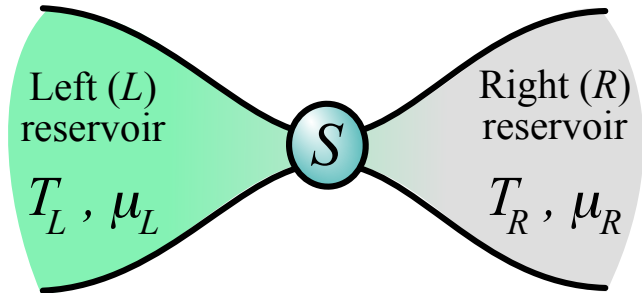

$$\eta = \frac{P}{J_{h,L}}$$

$$P = [(\mu_R - \mu_L)/e]J_e$$

$$(T_L > T_R, \mu_L < \mu_R) \quad P, J_{h,L} > 0$$

The upper bound to efficiency is given by the Carnot efficiency (expected only at zero power, since finite currents entail dissipation):

$$\eta_C = 1 - \frac{T_R}{T_L}$$

Scattering theory for two reservoirs

$$\mathcal{T}_{LR}(E) = \mathcal{T}_{RL}(E) \geq 0,$$

Conserved currents:

$$J_{e,L} = -J_{e,R} = \int_{-\infty}^{\infty} \frac{dE}{h} e \mathcal{T}_{LR}(E) [f_L(E) - f_R(E)],$$
$$J_{u,L} = -J_{u,R} = \int_{-\infty}^{\infty} \frac{dE}{h} E \mathcal{T}_{LR}(E) [f_L(E) - f_R(E)].$$

Heat currents:

$$J_{h,L} = \int_{-\infty}^{\infty} \frac{dE}{h} (E - \mu_L) \mathcal{T}_{LR}(E) [f_L(E) - f_R(E)],$$
$$J_{h,R} = \int_{-\infty}^{\infty} \frac{dE}{h} (E - \mu_R) \mathcal{T}_{LR}(E) [f_R(E) - f_L(E)],$$

First law of thermodynamics: $J_{h,L} + J_{h,R} = (V_R - V_L)J_{e,L}$

Thermoelectric efficiency (power production)

Charge current $J_e = eJ_\rho = \frac{e}{h} \int_{-\infty}^{\infty} dE \tau(E) [f_L(E) - f_R(E)]$

Heat current from reservoirs:

$$J_{h,\alpha} = \frac{1}{h} \int_{-\infty}^{\infty} dE (E - \mu_\alpha) \tau(E) [f_L(E) - f_R(E)]$$

Efficiency:

$$\eta = \frac{P}{J_{h,L}} \quad (T_L > T_R) \quad (\mu_R > \mu_L) \quad P, J_{h,L} > 0$$

$$\eta = \frac{[(\mu_R - \mu_L)/e] J_e}{J_{h,L}} = \frac{(\mu_R - \mu_L) \int_{-\infty}^{\infty} dE \tau(E) [f_L(E) - f_R(E)]}{\int_{-\infty}^{\infty} dE (E - \mu_L) \tau(E) [f_L(E) - f_R(E)]}$$

Delta-energy filtering and Carnot efficiency

If transmission is possible only inside a tiny energy window around $E=E_*$ then

$$\eta = \frac{\mu_L - \mu_R}{E_* - \mu_L}$$

In the limit $J_\rho \rightarrow 0$, corresponding to reversible transport

$$\frac{E_* - \mu_L}{T_L} = \frac{E_* - \mu_R}{T_R} \Rightarrow E_* = \frac{\mu_R T_L - \mu_L T_R}{T_L - T_R}$$

$$\eta = \eta_C = 1 - T_R/T_L \quad \text{Carnot efficiency}$$

Carnot efficiency obtained in the limit of reversible transport (zero entropy production) and zero output power

[Mahan and Sofo, PNAS 93, 7436 (1996);
Humphrey et al., PRL 89, 116801 (2002)]

Example: single-level quantum dot

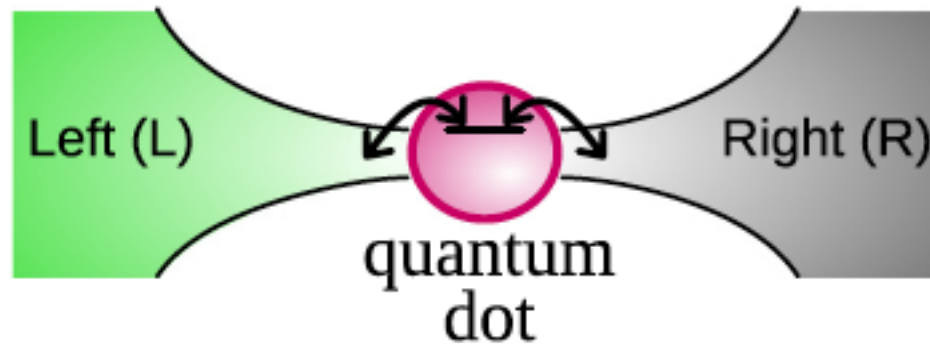

Γ_i/\hbar is the rate at which the dot state decays into reservoir i

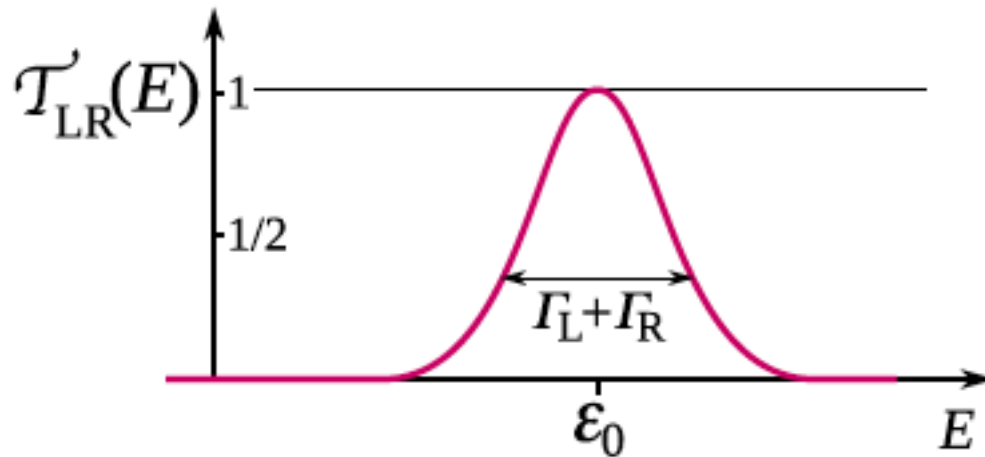

$$\mathcal{T}_{LR}(E) = \frac{\Gamma_L \Gamma_R}{(E - E_0)^2 + \frac{1}{4}(\Gamma_L + \Gamma_R)^2}$$

Short intermezzo: Cyclic thermal machines

The upper bound to efficiency is given by the Carnot efficiency:

$$\eta = \frac{W}{Q_H} \leq \eta_C = 1 - \frac{T_C}{T_H} \quad (T_H > T_C)$$

Carnot efficiency obtained for **quasi-static transformation** (zero extracted power)

The ideal Carnot engine is a **reversible machine**, since there is **no dissipation** (no entropy production)

Finite-time thermodynamics: endoreversible cyclic engines

Dissipation is due to finite thermal conductances between heat reservoirs and the ideal heat engine

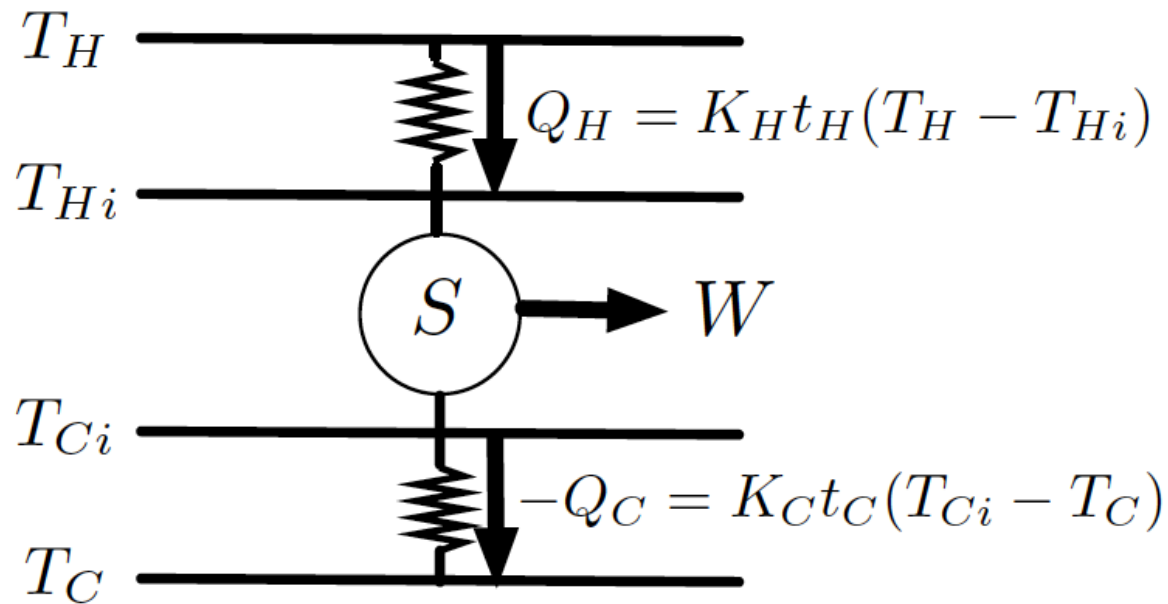

S is considered as a Carnot engine operating between the internal temperatures T_{Hi} and T_{Ci} ($T_H > T_{Hi} > T_{Ci} > T_C$)

$$1 - T_{Ci}/T_{Hi} = 1 + Q_C/Q_H$$

Output power:

$$P = \frac{W}{t} = \frac{Q_H + Q_C}{t} = \frac{K_H K_C \alpha \beta (T_H - T_C - \alpha - \beta)}{K_H \alpha T_C + K_C \beta T_H + \alpha \beta (K_H - K_C)}$$

Optimize power with respect to $\alpha = T_H - T_{Hi}$
 $\beta = T_{Ci} - T_C$

$$T_{Hi} = c \sqrt{T_H}, \quad T_{Ci} = c \sqrt{T_C}, \quad c \equiv \frac{\sqrt{K_H T_H} + \sqrt{K_C T_C}}{\sqrt{K_H} + \sqrt{K_C}}$$

$$P_{\max} = K_H K_C \left(\frac{\sqrt{T_H} - \sqrt{T_C}}{\sqrt{K_H} + \sqrt{K_C}} \right)^2$$

The efficient at maximum power (Curzon-Ahlborn efficiency) is independent of the heat conductances:

$$\eta_{CA} = 1 - \sqrt{\frac{T_H}{T_C}} = 1 - \sqrt{1 - \eta_C}$$

[Yvon, 1955; Chambadal, 1957; Novikov, 1958;
Curzon and Ahlborn, Am. J. Phys. 43, 22 (1975)]

Within linear response: $\eta_{CA} = \frac{\eta_C}{2}$

Bekenstein-Pendry bound

There is an **purely quantum** upper bound on the heat current through a single transverse mode

[Bekenstein, PRL **46**, 923 (1981); Pendry, JPA **16**, 2161 (1983)]

For a reservoir coupled to another reservoir at $T=0$ through a \mathcal{N} -mode constriction which lets particle flow at all energies:

$$J_{h,i}^{\max} = \frac{\pi^2}{6h} \mathcal{N} k_B^2 T_i^2$$

Maximum power of a heat engine

Since the heat flow must be less than the Bekenstein-Pendry bound and the efficiency smaller than Carnot efficiency also the output power must be bounded

Within scattering theory:

$$P \leq P_{\max} = A_q \frac{\pi^2}{h} \mathcal{N} k_B^2 (\Delta T)^2, \quad A_q \approx 0.0321,$$
$$\Delta T = T_L - T_R$$

[Whitney, PRL **112**, 130601 (2014); PRB **91**, 115425 (2015)]

Efficiency optimization (at a given power)

Find the transmission function that optimizes the heat-engine efficiency for a given output power

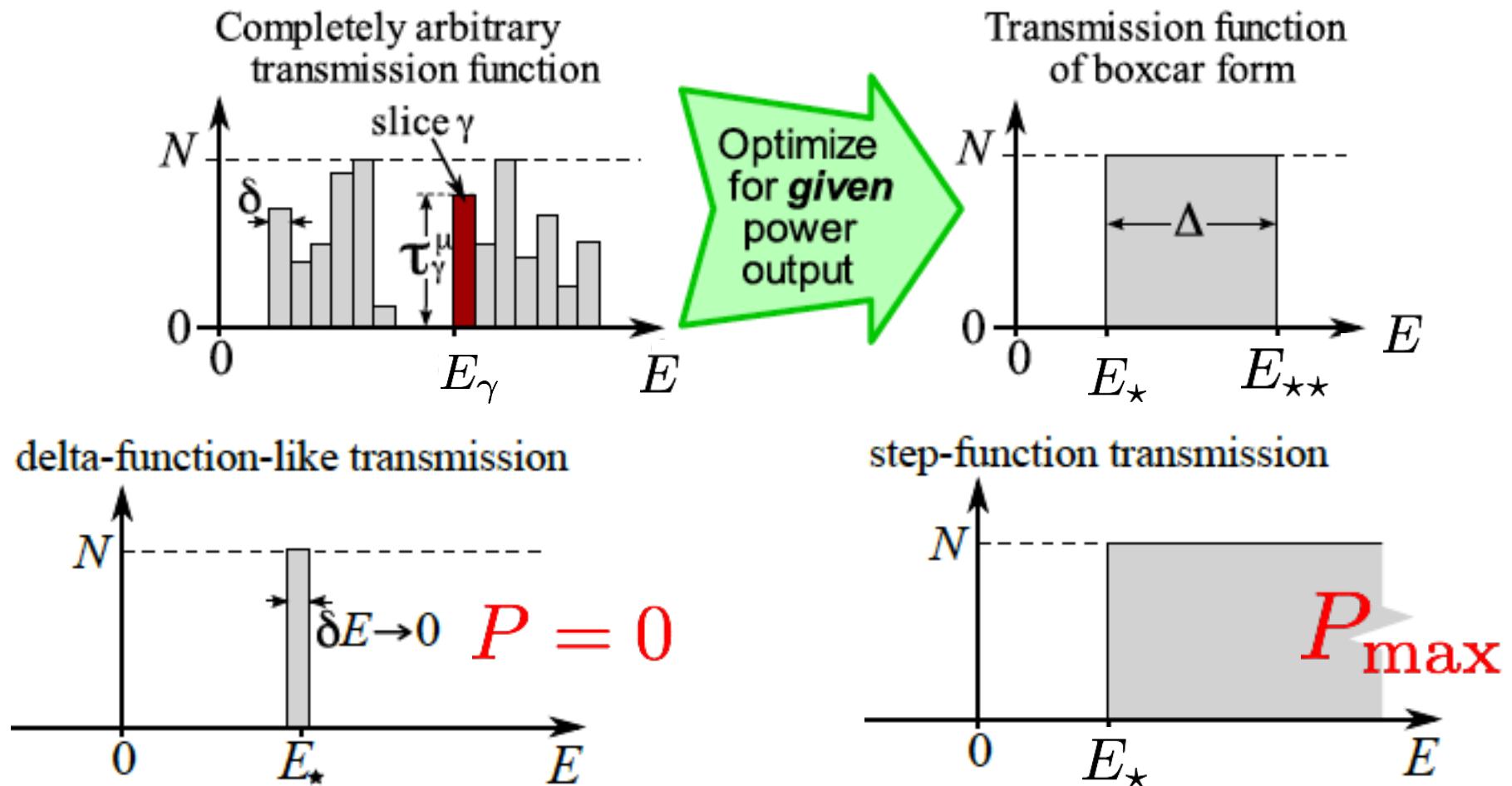

[Whitney, PRL **112**, 130601 (2014); PRB **91**, 115425 (2015)]

Trade-off between power and efficiency

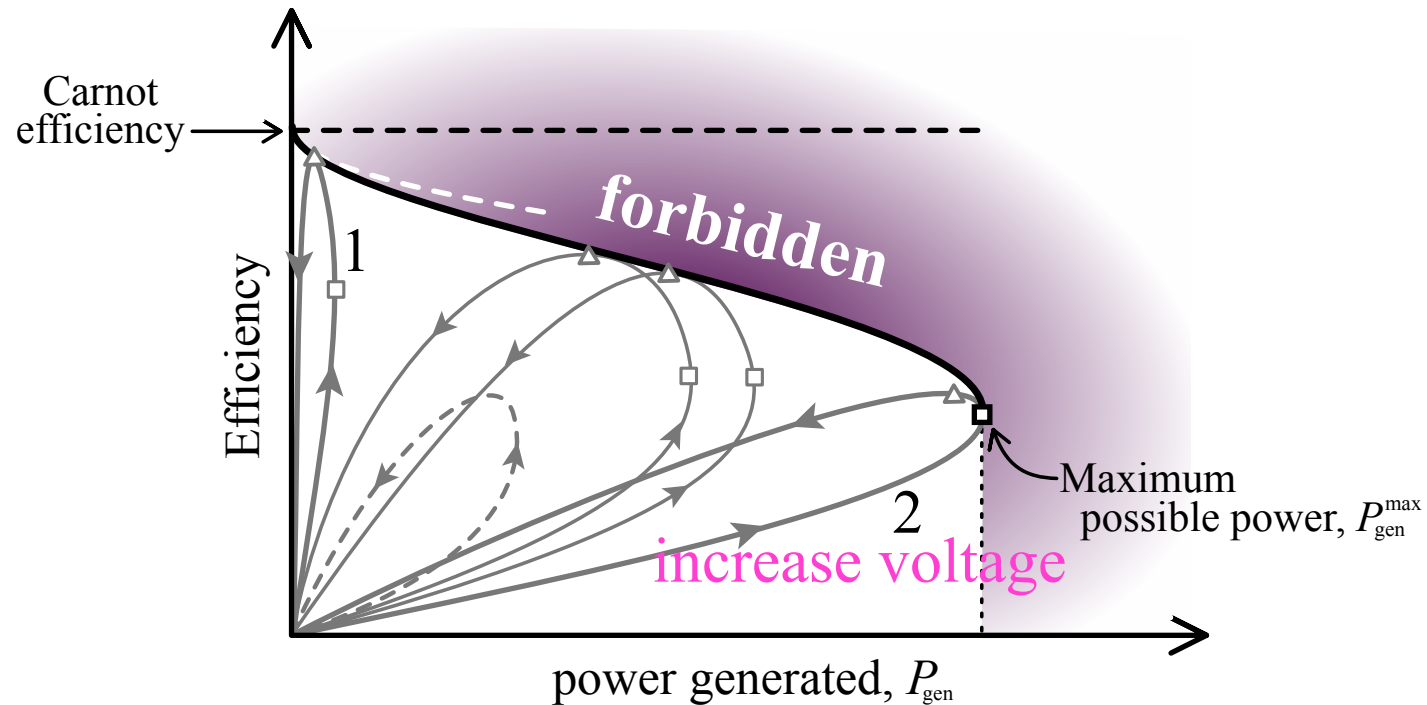

Result from (nonlinear) scattering theory

[Whitney, PRL **112**, 130601 (2014); PRB **91**, 115425 (2015)]

Power-efficiency trade-off including phonons

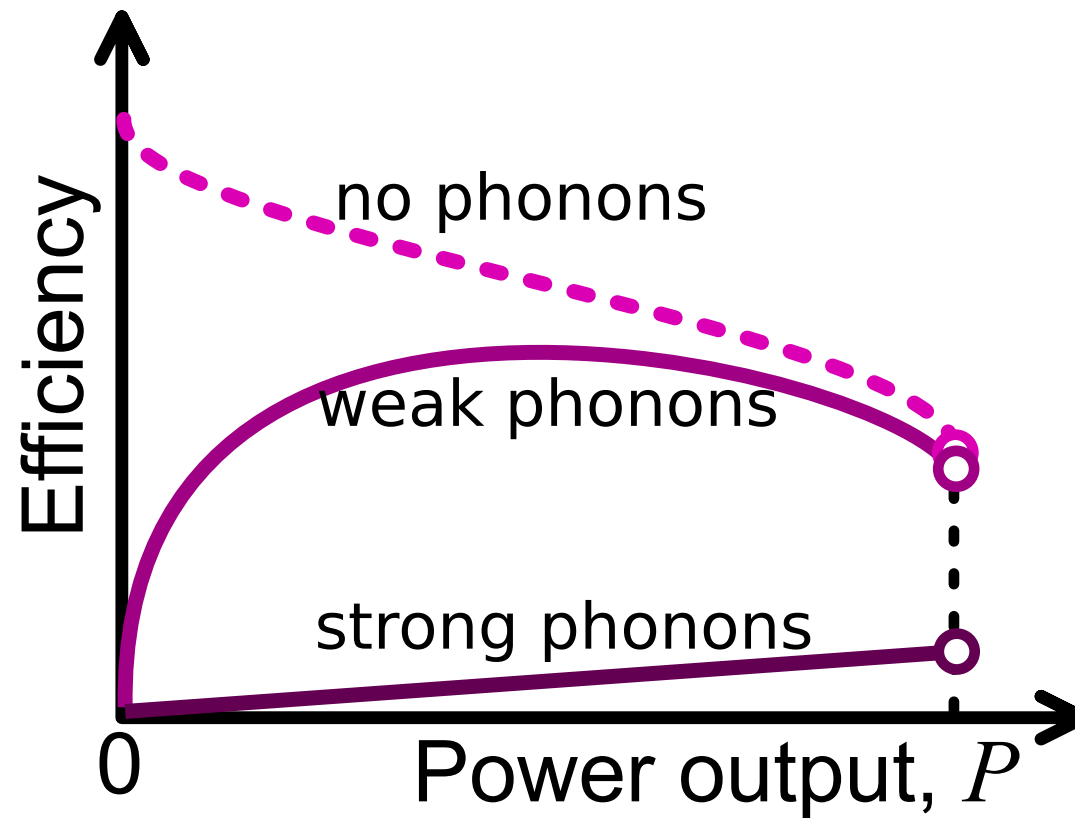

[see Whitney, PRB **91**, 115425 (2015)]

Boxcar transmission in topological insulators

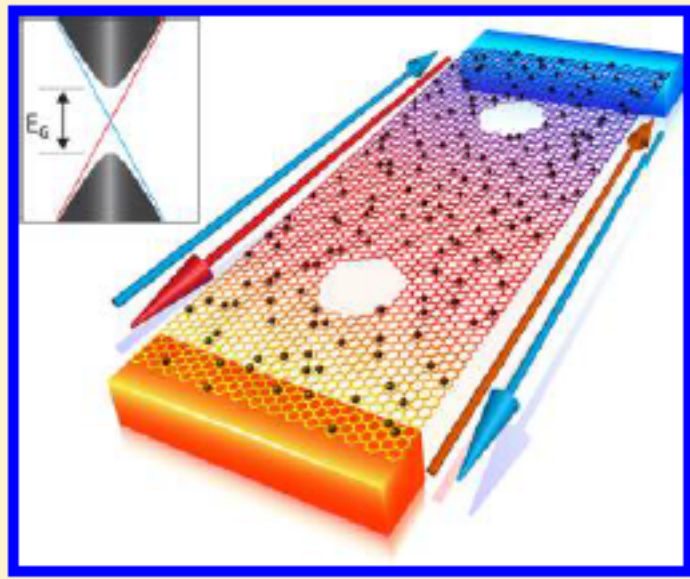

Graphene nanoribbons
with heavy adatoms
and nanopores

[Chang et al., Nanolett.,
14, 3779 (2014)]

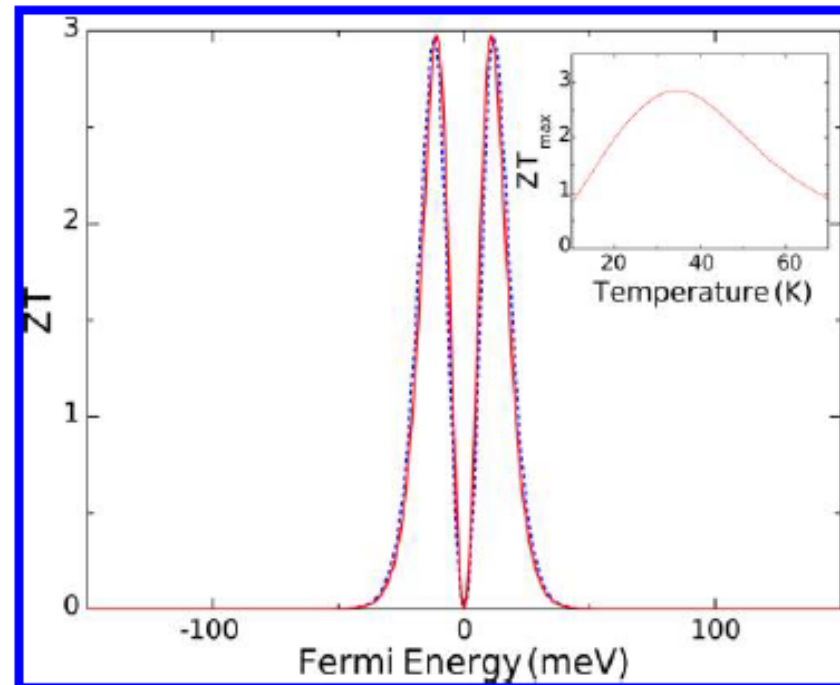
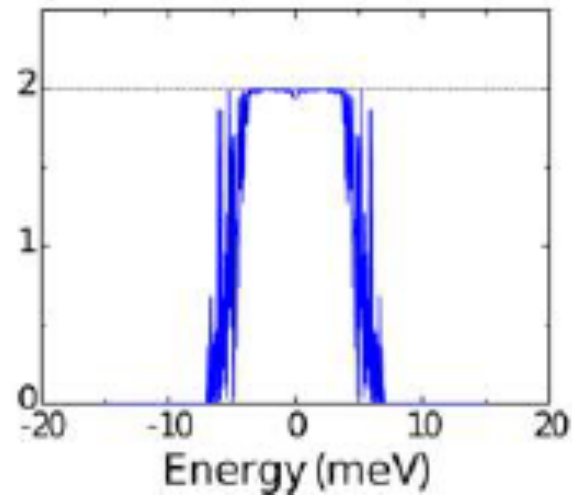

Linear response for coupled (particle and heat) flows

Stochastic baths: ideal gases at fixed temperature and electrochemical potential

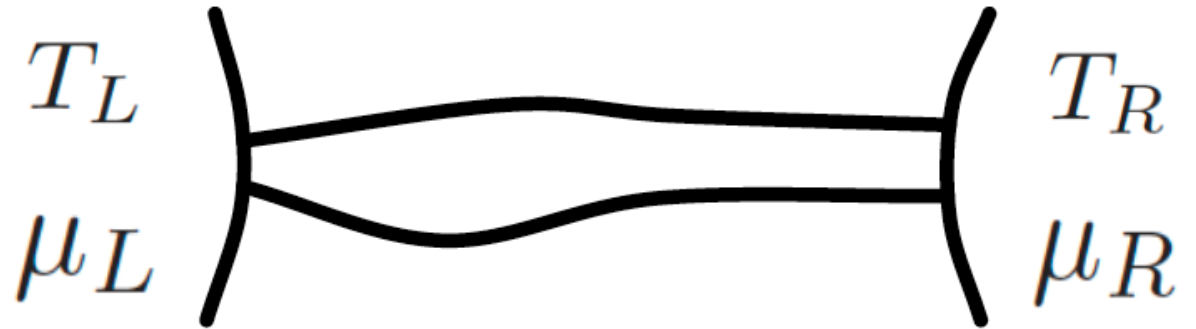

$$\begin{cases} J_e = L_{ee}\mathcal{F}_e + L_{eh}\mathcal{F}_h \\ J_h = L_{he}\mathcal{F}_e + L_{hh}\mathcal{F}_h \end{cases}$$

Onsager relation (for time-reversal symmetric systems):

$$L_{eh} = L_{he}$$

Positivity of entropy production:

$$L_{ee} \geq 0, \quad L_{hh} \geq 0, \quad \det \mathbf{L} \geq 0$$

$$\mathcal{F}_e = \Delta V/T \quad (\Delta V = \Delta\mu/e)$$

$$\mathcal{F}_h = \Delta T/T^2$$

$$\Delta\mu = \mu_L - \mu_R$$

$$\Delta T = T_L - T_R$$

(we assume $T_L > T_R$, $\mu_L < \mu_R$)

Onsager and transport coefficients

$$G = \left(\frac{J_e}{\Delta V} \right)_{\Delta T=0} = \frac{L_{ee}}{T}$$

$$K = \left(\frac{J_h}{\Delta T} \right)_{J_e=0} = \frac{1}{T^2} \frac{\det \mathbf{L}}{L_{ee}}$$

$$S = - \left(\frac{\Delta V}{\Delta T} \right)_{J_e=0} = \frac{1}{T} \frac{L_{eh}}{L_{ee}}$$

Note that the positivity of entropy production implies that the (isothermal) electric conductance $G > 0$ and the thermal conductance $K > 0$

Local equilibrium

Under the assumption of local equilibrium we can write phenomenological equations with ∇T and $\nabla \mu$ rather than ΔT and $\Delta \mu$

$$\begin{cases} j_e = \lambda_{ee}(-\nabla \mu / eT) + \lambda_{eh} \nabla(1/T), \\ j_h = \lambda_{he}(-\nabla \mu / eT) + \lambda_{hh} \nabla(1/T) \end{cases}$$

j_e, j_h charge and heat current densities

In this case we connect Onsager coefficients to **electric and thermal conductivity** rather than to conductances

$$\sigma = \left(\frac{j_e}{\nabla V} \right)_{\nabla T=0}, \quad \kappa = \left(\frac{j_h}{\nabla T} \right)_{j_e=0}$$

Linear response?



$$T_H \sim 600 - 700 \text{ K}$$

(exhaust gases)

$$T_C \sim 270 - 300 \text{ K}$$

(room temperature)

Figure 1 | Integrating thermoelectrics into vehicles for improved fuel efficiency. Shown is a BMW 530i concept car with a thermoelectric generator (yellow; and inset) and radiator (red/blue).

[Vining, Nat. Mater. **8**, 83 (2009)]

Linear response for small temperature and electrochemical potential differences (compared to the average temperature)
on the scale of the relaxation length

Exhaust pipe: temperature drop over a mm scale:
temperature drop of 0.003 K on the relaxation length scale
(of 10 nm)

Maximum efficiency

Within linear response and for steady-state heat to work conversion:

$$\eta = \frac{P}{\dot{Q}_L} = \frac{-(\Delta V)J_e}{J_h} = \frac{-T\mathcal{F}_e(L_{ee}\mathcal{F}_e + L_{eh}\mathcal{F}_h)}{L_{he}\mathcal{F}_e + L_{hh}\mathcal{F}_h}$$

Find the maximum of η over \mathcal{F}_e for fixed \mathcal{F}_h i.e., over the applied voltage ΔV for fixed temperature difference ΔT)

Maximum achieved for $\mathcal{F}_e = \frac{L_{hh}}{L_{he}} \left(-1 + \sqrt{\frac{\det \mathbf{L}}{L_{ee}L_{hh}}} \right) \mathcal{F}_h$

Maximum efficiency (for system with time-reversal symmetry)

$$\eta_{\max} = \eta_C \frac{\sqrt{ZT + 1} - 1}{\sqrt{ZT + 1} + 1} \quad (T_L \approx T_R \approx T)$$

Thermoelectric figure of merit

$$ZT \equiv \frac{L_{eh}^2}{\det \mathbf{L}} = \frac{GS^2}{K} T$$

Positivity of entropy production implies $ZT > 0$

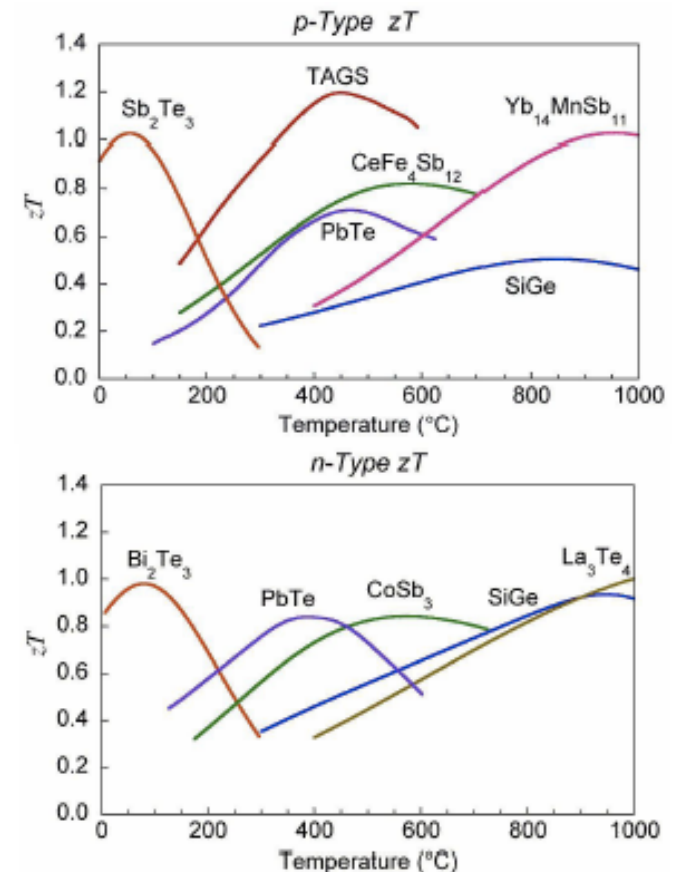
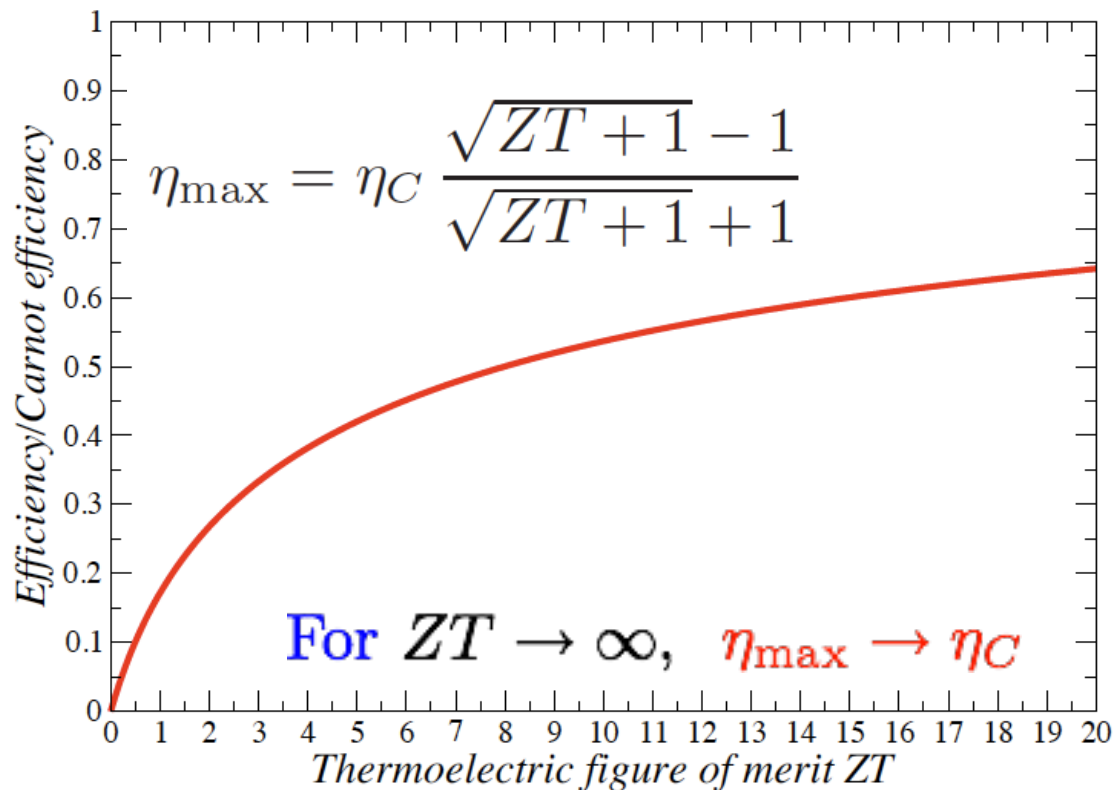

Efficiency at maximum power

Output power $P = -(\Delta V)J_e = -T\mathcal{F}_e(L_{ee}\mathcal{F}_e + L_{eh}\mathcal{F}_h)$

Find the maximum of P over \mathcal{F}_e for fixed \mathcal{F}_h (over the applied voltage ΔV for fixed ΔT)

Maximum achieved for $\mathcal{F}_e = -\frac{L_{eh}}{2L_{ee}}\mathcal{F}_h$

Maximum output power

$$P_{\max} = \frac{T}{4} \frac{L_{eh}^2}{L_{ee}} \mathcal{F}_h^2 = \frac{1}{4} S^2 G (\Delta T)^2$$

Power factor $S^2 G$

P quadratic function of \mathcal{F}_e , with maximum at half of the *stopping force*:

$$\mathcal{F}_e^{\text{stop}} = -\frac{L_{eh}}{L_{ee}} \mathcal{F}_h, \quad J_e(\mathcal{F}_e^{\text{stop}}) = 0$$

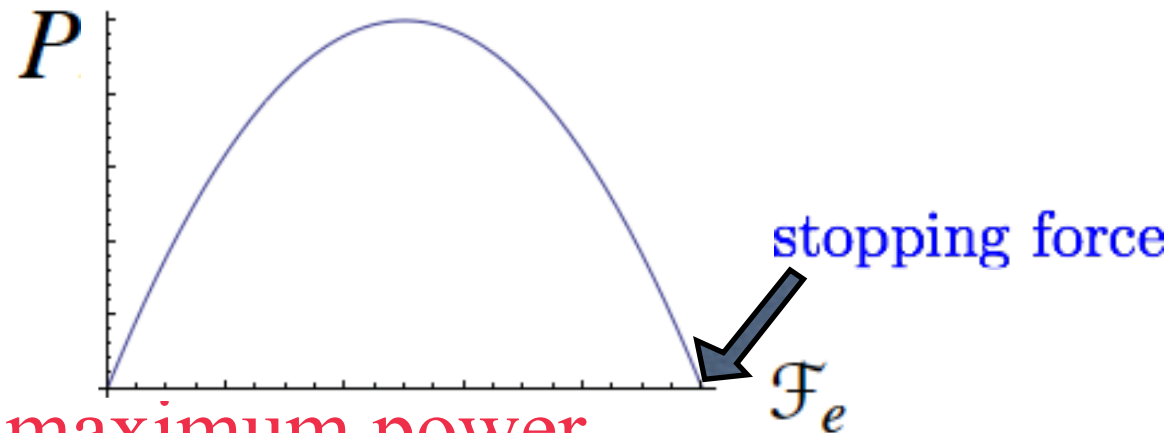

Efficiency at maximum power

$$\eta(P_{\text{max.}}) = \frac{\eta_C}{2} \frac{ZT}{ZT + 2} \leq \eta_{CA} \equiv \frac{\eta_C}{2}$$

η_{CA} Curzon-Ahlborn upper bound

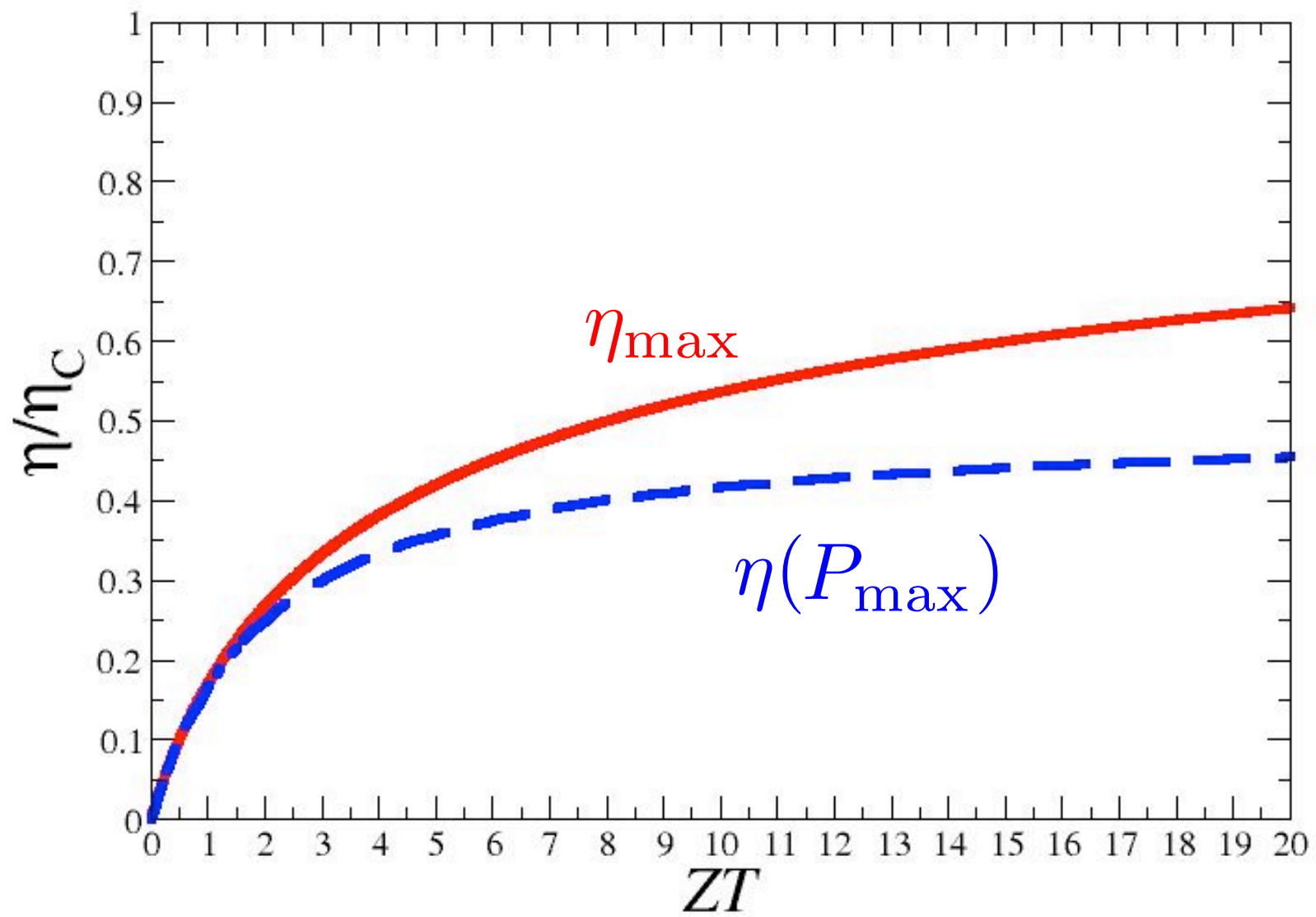

Efficiency versus power

$$r = \mathcal{F}_e / \mathcal{F}_e^{\text{stop}} \quad \frac{P}{P_{\text{max}}} = 4r(1 - r) \quad \Rightarrow \quad r = \frac{1}{2} \left[1 \pm \sqrt{1 - \frac{P}{P_{\text{max}}}} \right]$$

$$\frac{\eta}{\eta_C} = \frac{\frac{P}{P_{\text{max}}}}{2 \left(1 + \frac{2}{ZT} \mp \sqrt{1 - \frac{P}{P_{\text{max}}}} \right)}$$

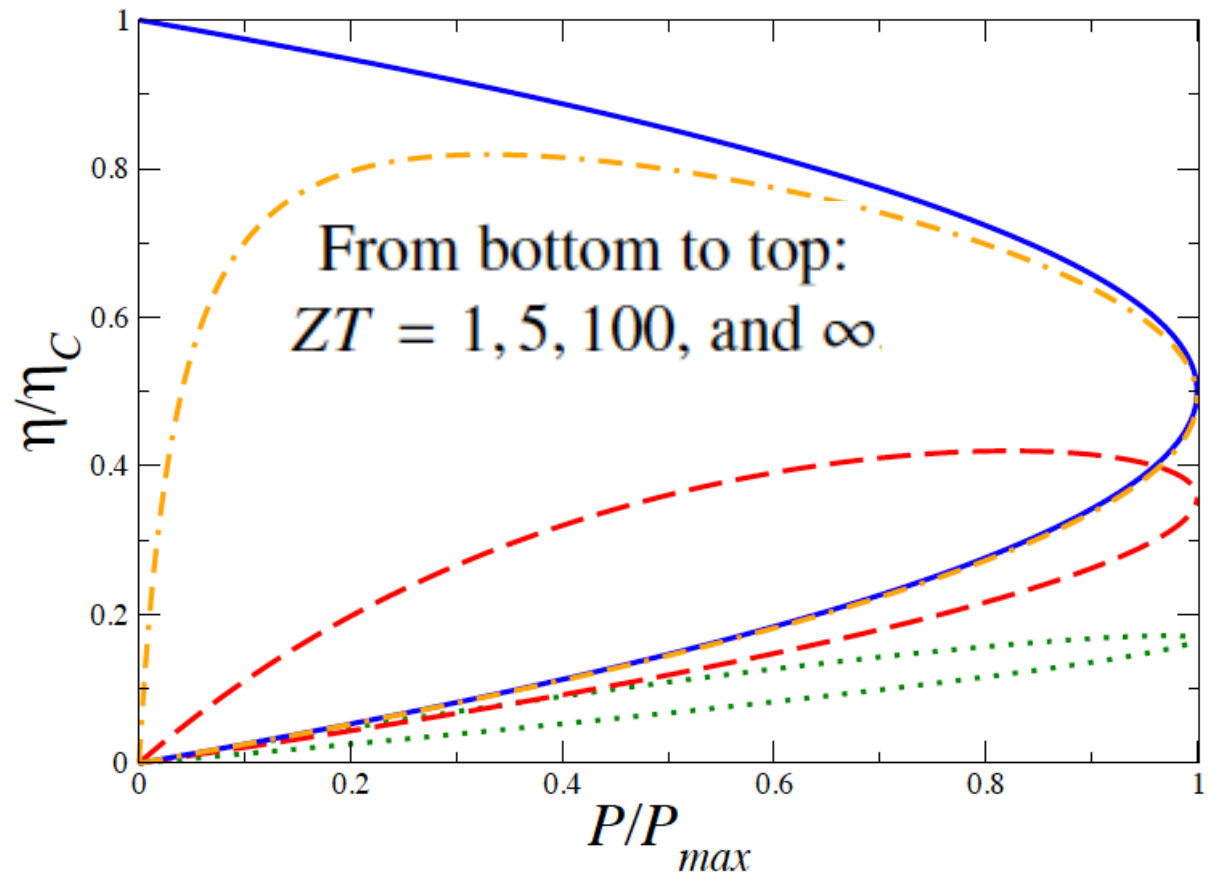

Linear response and Landauer formalism

The Onsager coefficients are obtained from the linear response expansion of the charge and thermal currents

$$f_L(E) \approx f(E) + \frac{\partial f}{\partial T} \Delta T + \frac{\partial f}{\partial \mu} \Delta \mu = f(E) - \frac{\partial f}{\partial E} \left[(E - \mu) \frac{\Delta T}{T} + \Delta \mu \right]$$

$$-\frac{\partial f}{\partial E} = \frac{1}{4k_B T \cosh^2[(E - \mu)/2k_B T]}$$

$$L_{ee} = e^2 T I_0, \quad L_{eh} = L_{he} = e T I_1, \quad L_{hh} = T I_2$$

$$I_n = \frac{1}{h} \int_{-\infty}^{\infty} dE (E - \mu)^n \tau(E) \left(-\frac{\partial f}{\partial E} \right)$$

Wiedemann-Franz law

Phenomenological law: the ratio of the thermal to the electrical conductivity is directly proportional to the temperature, with a universal proportionality factor.

$$\frac{\kappa}{\sigma} = \mathcal{L}T$$

Lorenz number

$$\mathcal{L} = \frac{\pi^2}{3} \left(\frac{k_B}{e} \right)^2$$

Sommerfeld expansion

The Wiedemann-Franz law can be derived for low-temperature non-interacting systems both within kinetic theory or Landauer approach

In both cases it is substantiated by Sommerfeld expansion. Within Landauer approach we consider

$$J_{h,L} = \frac{1}{h} \int_{-\infty}^{\infty} dE (E - \mu_L) \tau(E) [f_L(E) - f_R(E)]$$

$$J_e = eJ_\rho = \frac{e}{h} \int_{-\infty}^{\infty} dE \tau(E) [f_L(E) - f_R(E)]$$

We assume smooth transmission functions $\tau(E)$ in the neighborhood of $E=\mu$:

$$\tau(E) \approx \tau(\mu) + \left. \frac{d\tau(E)}{dE} \right|_{E=\mu} (E - \mu)$$

To leading order in $k_B T/E_F$ with $E_F = \mu(T = 0)$

$$I_0 \approx \frac{\tau(\mu)}{h}, \quad I_1 \approx \frac{\pi^2}{3h} (k_B T)^2 \left. \frac{d\tau(E)}{dE} \right|_{E=\mu}, \quad I_2 \approx \frac{\pi^2}{3h} (k_B T)^2 \tau(\mu)$$

$$G = e^2 I_0 \approx \frac{e^2}{h} \tau(\mu), \quad K = \frac{1}{T} \left(I_2 - \frac{I_1^2}{I_0} \right) \approx \frac{\pi^2 k_B^2 T}{3h} \tau(\mu)$$

Neglected I_1^2/I_0 with respect to I_2 , which in turn implies $L_{ee}L_{hh} \gg (L_{eh})^2$ and $K \approx L_{hh}/T^2$

Wiedemann-Franz law:

$$\frac{K}{G} \approx \frac{\pi^2}{3} \left(\frac{k_B}{e} \right)^2 T$$

Wiedemann-Franz law and thermoelectric efficiency

$$ZT = \frac{GS^2}{K} T = \frac{S^2}{\mathcal{L}}$$

Wiedemann-Franz law derived under the condition $L_{ee}L_{hh} \gg (L_{eh})^2$ and therefore

$$ZT = L_{eh}^2 / \det \mathbf{L} \approx L_{eh}^2 / L_{ee}L_{hh} \ll 1$$

Wiedemann-Franz law violated in

- low-dimensional interacting systems that exhibit non-Fermi liquid behavior
- (small) systems where transmission can show significant energy dependence

(Violation of) Wiedemann-Franz law in small systems

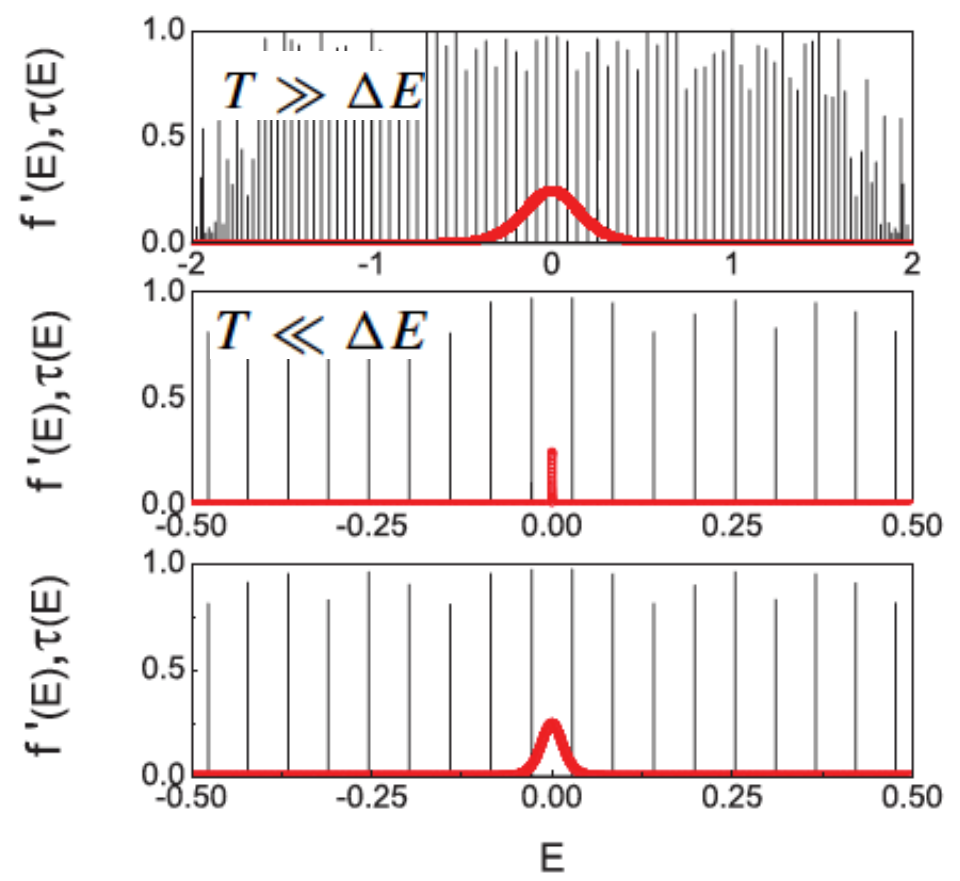
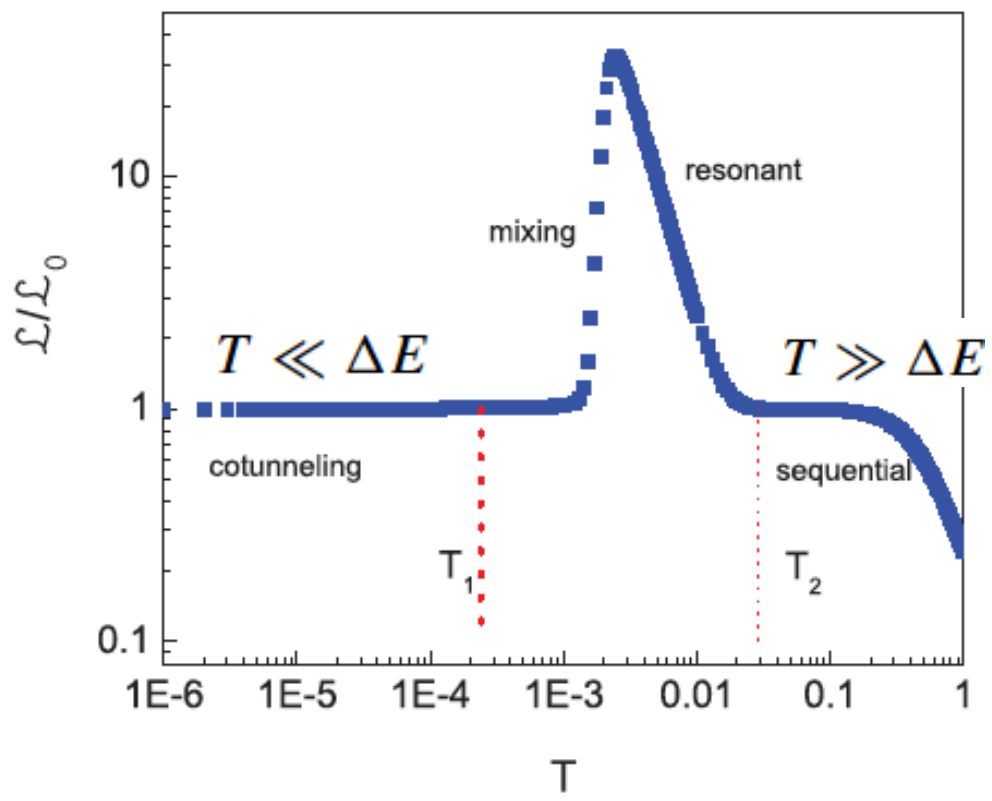

(Bosisio, Balachandran, Benenti, PRB **86**, 035433 (2012);
 see also Vavilov and Stone, PRB **72**, 205107 (2005))

Mott's formula for thermopower

For non-interacting electrons (thermopower vanishes when there is particle-hole symmetry)

$$S = \frac{1}{eT} \frac{I_1}{I_0} = \frac{1}{eT} \frac{\int_{-\infty}^{\infty} dE (E - \mu) \tau(E) \left(-\frac{\partial f}{\partial E}\right)}{\int_{-\infty}^{\infty} dE \tau(E) \left(-\frac{\partial f}{\partial E}\right)} = \frac{1}{eT} \langle E - \mu \rangle$$

Consider smooth transmissions $\tau(E) \approx \tau(\mu) + \tau'(\mu)(E - \mu)$

$$S \approx \frac{\pi^2 k_B^2 T}{3e} \frac{\tau'(\mu)}{\tau(\mu)} = \frac{\pi^2 k_B^2 T}{3e} \left. \frac{d \ln G(E)}{dE} \right|_{E=\mu}$$

Electron and holes contribute with opposite signs: we want **sharp, asymmetric transmission functions** to have large thermopowers (ex: resonances, Anderson QPT, see Imry and Amir, 2010), violation of WF, large ZT.

Metal-insulator 3D Anderson transition

$$\sigma = \int_{-\infty}^{\infty} dE \sigma_0(E) \left(-\frac{\partial f}{\partial E} \right)$$
$$\sigma_0(E) = \begin{cases} A(E - E_m)^x, & \text{if } E \geq E_m, \\ 0, & \text{if } E \leq E_m, \end{cases}$$

x conductivity critical exponent

[G.B., H. Ouerdane, C. Goupil, arXiv:1602.06590; Comptes Rendus Physique, in press]

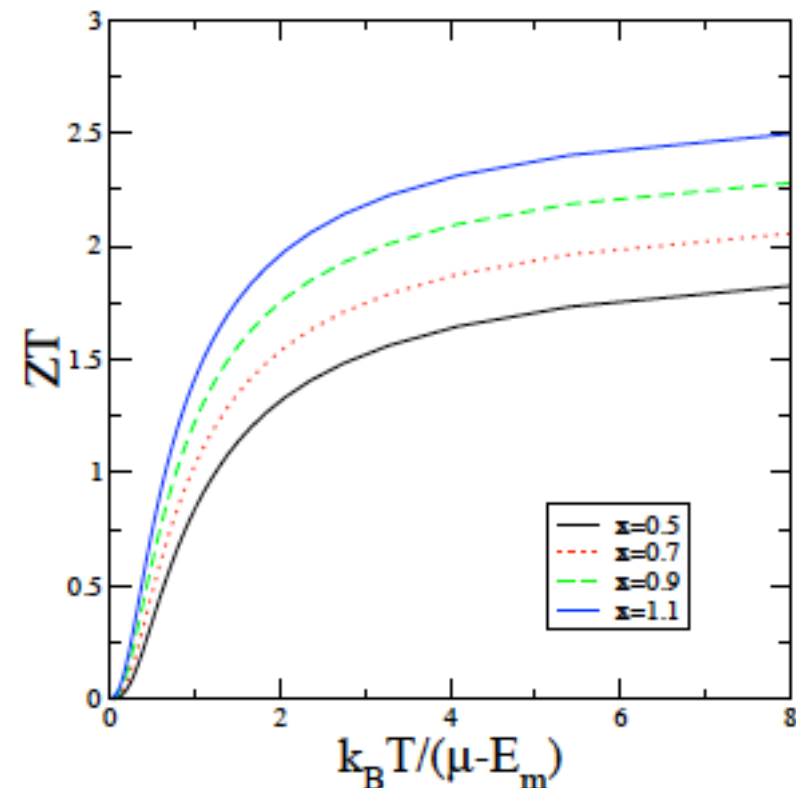

Energy filtering

$$\frac{K}{G} = \frac{\langle (E - \mu)^2 \rangle - \langle E - \mu \rangle^2}{e^2 T}$$

For good thermoelectric we desire violation of WF law:

$$K/G \rightarrow 0$$

$$ZT = \frac{\langle (E - \mu) \rangle^2}{\langle (E - \mu)^2 \rangle - \langle (E - \mu) \rangle^2}$$

No dispersion with delta-energy filtering: ZT diverges

**Thermoelectricity in the
Coulomb blockade regime,
Kinetic equations.
Quantum dot model**

Multilevel interacting quantum dot

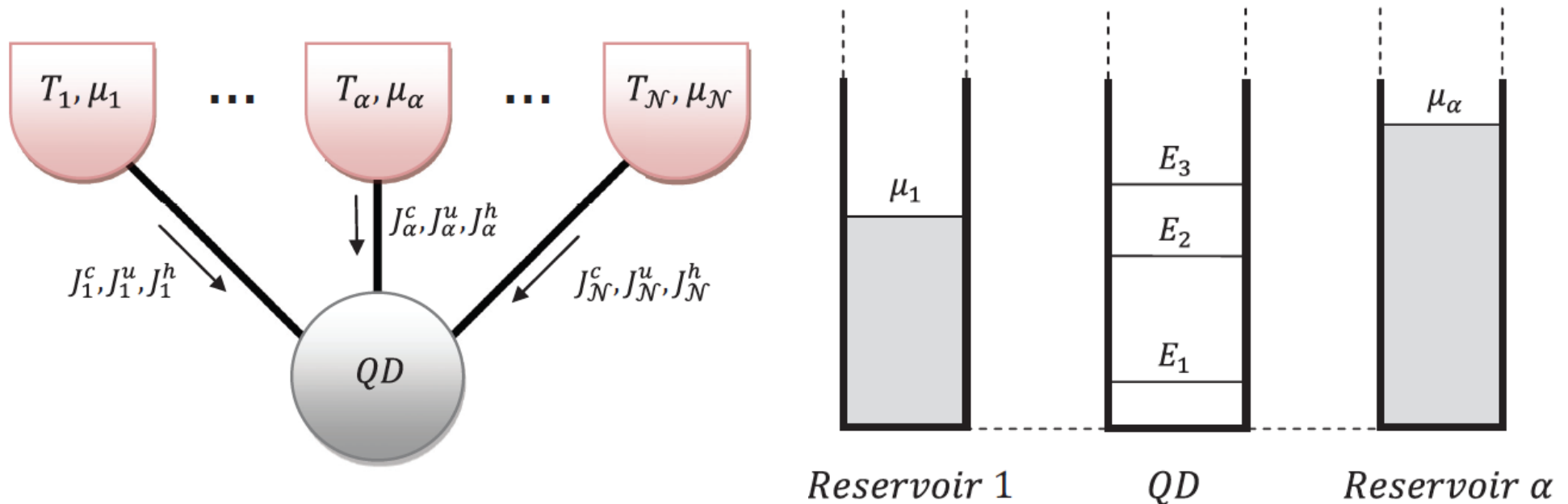

Discrete energy levels: ideal to implement energy filtering

Study the effects of Coulomb interaction between electrons

[Erdmann, Mazza, Bosisio, G.B., Fazio, Taddei PRB **95**, 245432 (2017)]

Sequential (single-electron) tunnelling regime

E_p (with $p = 1, 2, \dots$) single-electron levels of the QC

C capacitance

N number of electrons in the dot

$(Ne)^2/2C$ electrostatic (Coulomb) interaction

$\Gamma_\alpha(p)$ tunneling rate from level p to reservoir α

Weak coupling to the reservoirs: thermal energy $k_B T$, level spacing and charging energy much larger than the coupling energy $\hbar \sum_\alpha \Gamma_\alpha(p)$ between the QD and the reservoirs: **charge quantized** $n_p = 0$ or $n_p = 1$ $N = \sum_i n_i$

Electrostatic energy $U(N) = E_C N^2,$

single-electron charging energy $E_C = e^2/2C$

Energy conservation

Configuration determined by occupation numbers $\{n_i\}$

Non-equilibrium probability $P(\{n_i\})$

Energy conservation for tunnelling into or from reservoirs:

$$E_p + U(N) = E^{\text{fin}}(N) + U(N - 1)$$

$$E^{\text{in}}(N) + U(N) = E_p + U(N + 1)$$

Kinetic equations

One kinetic equation for each configuration:

$$\begin{aligned} \frac{\partial}{\partial t} P(\{n_i\}) = & - \sum_{p\alpha} \delta_{n_p,0} P(\{n_i\}) \Gamma_\alpha(p) f_\alpha(E^{\text{in}}(N)) \\ & - \sum_{p\alpha} \delta_{n_p,1} P(\{n_i\}) \Gamma_\alpha(p) [1 - f_\alpha(E^{\text{fin}}(N))] \\ + \sum_{p\alpha} \delta_{n_p,0} P(\{n_i\}, n_p = 1) \Gamma_\alpha(p) [1 - f_\alpha(E^{\text{fin}}(N + 1))] \\ & + \sum_{p\alpha} \delta_{n_p,1} P(\{n_i\}, n_p = 0) \Gamma_\alpha(p) f_\alpha(E^{\text{in}}(N - 1)), \\ P(\{n_i\}, n_p = 1) = & P(\{n_1, \dots, n_{p-1}, 1, n_{p+1}, \dots\}) \\ P(\{n_i\}, n_p = 0) = & P(\{n_1, \dots, n_{p-1}, 0, n_{p+1}, \dots\}) \end{aligned}$$

Stationary solution: $\partial P / \partial t = 0$, $\sum_{\{n_i\}} P(\{n_i\}) = 1$

Steady-state currents

Charge current:

$$J_{e,\alpha} = e \sum_{p=1}^{\infty} \sum_{\{n_i\}} P(\{n_i\}) \Gamma_{\alpha}(p) \left\{ \delta_{n_p,0} f_{\alpha}(E^{\text{in}}(N)) - \delta_{n_p,1} [1 - f_{\alpha}(E^{\text{fin}}(N))] \right\}$$

Energy current:

$$J_{u,\alpha} = \sum_{p=1}^{\infty} \sum_{\{n_i\}} P(\{n_i\}) \Gamma_{\alpha}(p) \left\{ \delta_{n_p,0} f_{\alpha}(E^{\text{in}}(N)) E^{\text{in}}(N) - \delta_{n_p,1} [1 - f_{\alpha}(E^{\text{fin}}(N))] E^{\text{fin}}(N) \right\}$$

Heat current:

$$J_{h,\alpha} = J_{u,\alpha} - (\mu_{\alpha}/e) J_{e,\alpha}$$

Quantum limit

Energy spacing and charging energy much bigger than $k_B T$

Analytical results for equidistant levels: $E_p - E_{p-1} = \Delta E$

$$E_C = 50 k_B T, \quad \Delta E = 10 k_B T,$$

$$\hbar\Gamma_1(p) = \hbar\Gamma_2(p) = (1/100) k_B T$$

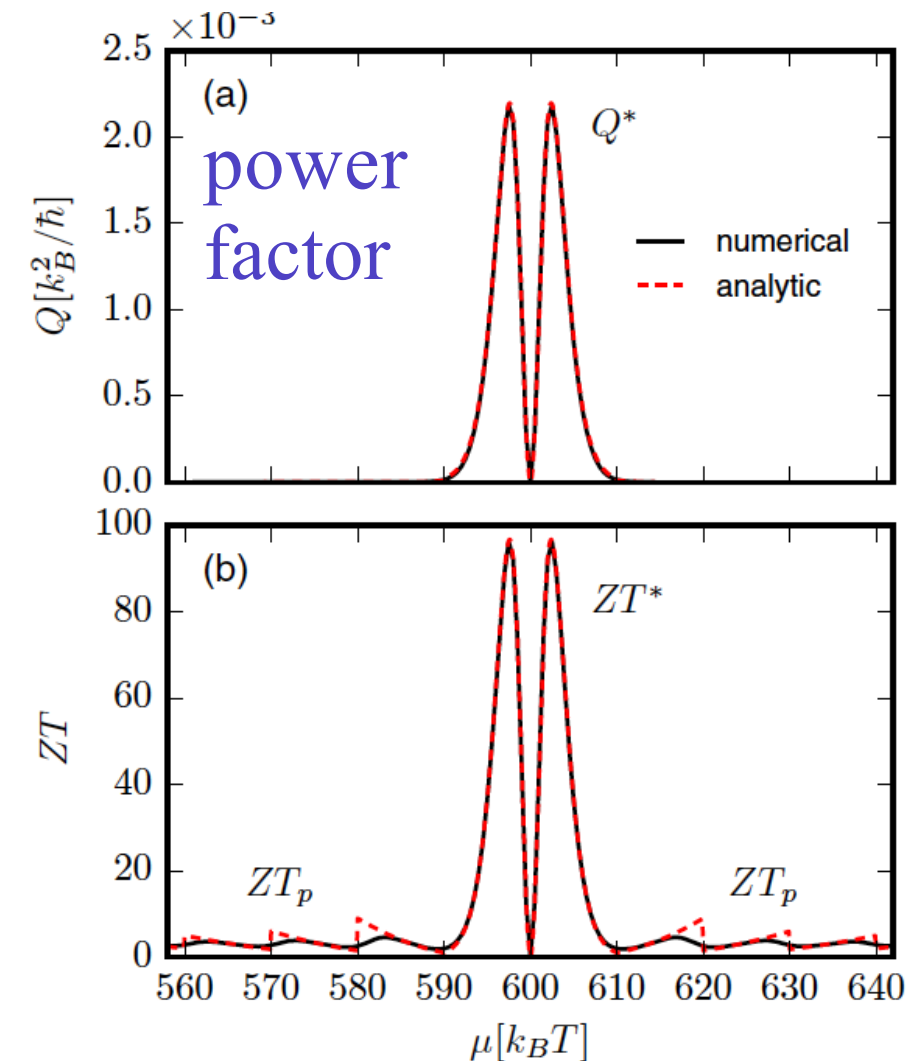

$$ZT^* \approx 0.44 \frac{e^{\Delta E/k_B T}}{(\Delta E/k_B T)^2}$$

(energy filtering)

Coulomb interaction may enhance the thermoelectric performance of a QD

Compare interacting and non-interacting two-terminal QD with the same energy spacing

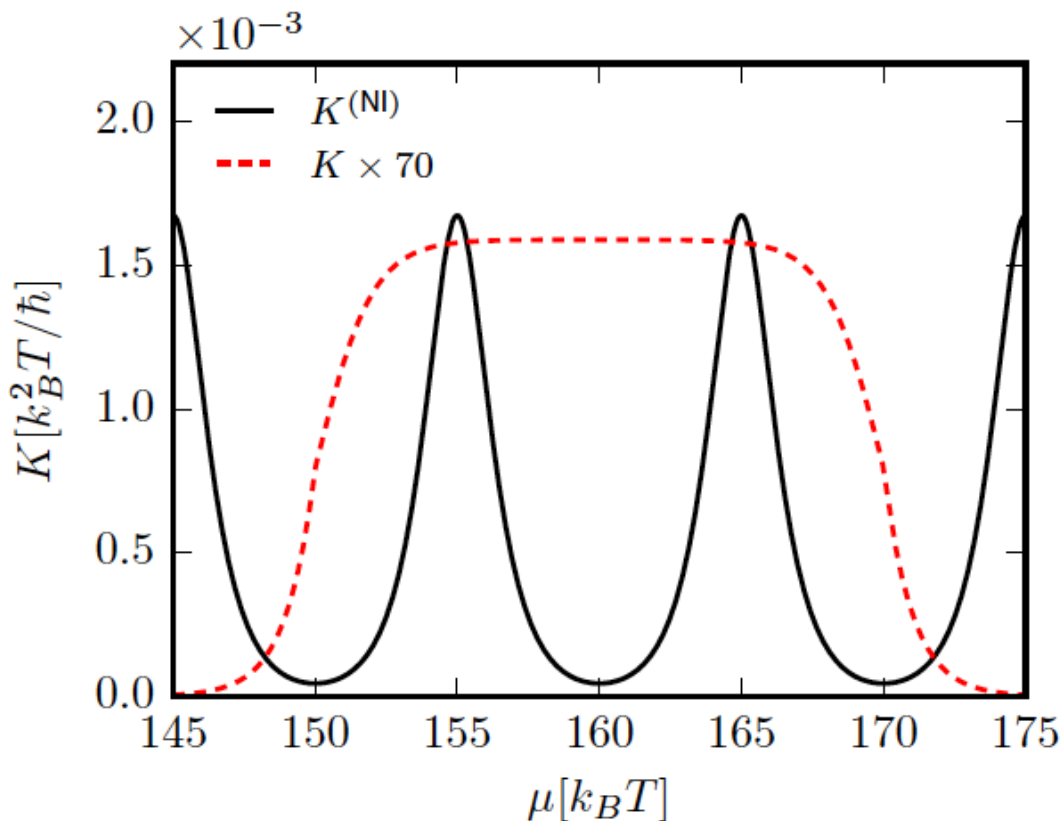

Thermal conductance suppressed by Coulomb interaction: ZT is greatly increased.

For a single level $K=0$ (charge and heat current proportional). For at least two levels Coulomb blockade prevents a second electron to enter when one is already there (electrostatic energy to be paid).

**Strongly interacting systems,
Electronic Phase transitions,
Power-efficiency trade-off,
Power-efficiency-fluctuations trade-off,
Carnot efficiency at finite power?
Generality of Onsager reciprocal relations**

Short intermezzo: a reason why interactions might be interesting for thermoelectricity

$$K' \equiv \left(\frac{J_h}{\Delta T} \right)_{\Delta V=0} \quad \text{thermal conductance at zero voltage}$$

$$ZT = \gamma_K - 1, \quad \gamma_K \equiv \frac{K'}{K}$$

If the ratio K'/K diverges, then the Carnot efficiency is achieved

Thermodynamic properties of the working fluid

$$dN = \left. \frac{\partial N}{\partial \mu} \right|_T d\mu + \left. \frac{\partial N}{\partial T} \right|_{\mu} dT,$$

$$d\mathcal{S} = -\frac{\mu}{T} dN + \frac{dU}{T} = -\frac{\mu}{T} \left(\left. \frac{\partial N}{\partial \mu} \right|_T d\mu + \left. \frac{\partial N}{\partial T} \right|_{\mu} dT \right) + \frac{1}{T} \left(\left. \frac{\partial U}{\partial N} \right|_T dN + \left. \frac{\partial U}{\partial T} \right|_N dT \right)$$

coupled equations:

$$\begin{cases} dN = C_{NN}d\mu + C_{N\mathcal{S}}dT, \\ d\mathcal{S} = C_{\mathcal{S}N}d\mu + C_{\mathcal{S}\mathcal{S}}dT, \end{cases}$$

$$C_{NN} = \left. \frac{\partial N}{\partial \mu} \right|_T, \quad C_{N\mathcal{S}} = \left. \frac{\partial N}{\partial T} \right|_{\mu},$$

$$C_{\mathcal{S}N} = \frac{1}{T} \left. \frac{\partial N}{\partial \mu} \right|_T \left(\left. \frac{\partial U}{\partial N} \right|_T - \mu \right),$$

capacity matrix \mathbf{C}

$$C_{\mathcal{S}\mathcal{S}} = \frac{1}{T} \left[\left. \frac{\partial U}{\partial T} \right|_N + \left. \frac{\partial N}{\partial T} \right|_{\mu} \left(\left. \frac{\partial U}{\partial N} \right|_T - \mu \right) \right]$$

$$C_{N\mathcal{S}} = C_{\mathcal{S}N}$$

(Vining, MRS Symp. **478**, 3 (1997))

$$C_{\mathcal{S}\mathcal{S}} = \left(\frac{\partial \mathcal{S}}{\partial T} \right)_{\mu} \equiv C_{\mu} \quad \text{entropy capacity at constant } \mu$$

Setting $dN=0$ in the coupled equations:

$$C_N \equiv \left(\frac{\partial \mathcal{S}}{\partial T} \right)_N = \frac{\det \mathbf{C}}{C_{NN}} \quad \text{entropy capacity at constant } N$$

Thermodynamic cycle

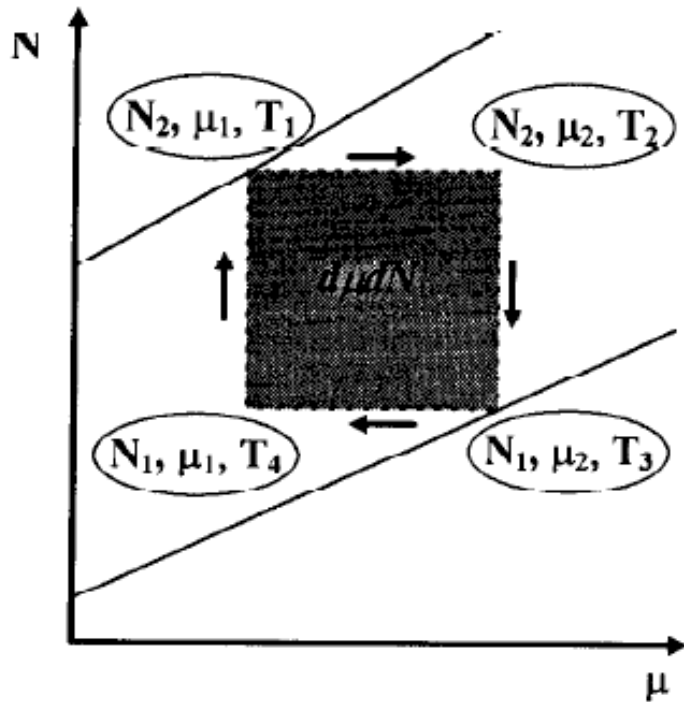

$$\frac{\eta}{\eta_C} = \frac{-d\mu dN}{d\mathcal{S}dT}$$

$$\eta = \frac{-d\mu dN}{Td\mathcal{S}} = \frac{-d\mu(C_{NN}d\mu + C_{N\mathcal{S}}dT)}{T(C_{\mathcal{S}N}d\mu + C_{\mathcal{S}\mathcal{S}}dT)}$$

maximum efficiency
(over $d\mu$ at fixed dT):

$$\eta_{\max} = \eta_C \frac{\sqrt{Z_{\text{th}}T + 1} - 1}{\sqrt{Z_{\text{th}}T + 1} + 1}$$

thermodynamic figure of merit:

$$Z_{\text{th}}T = \frac{C_{N\mathcal{S}}^2}{\det \mathbf{C}} = \gamma_{\mu N} - 1, \quad \gamma_{\mu N} \equiv \frac{C_{\mu}}{C_N}$$

Analogy with a classical gas

$$N \rightarrow V, \quad \mu \rightarrow -p$$

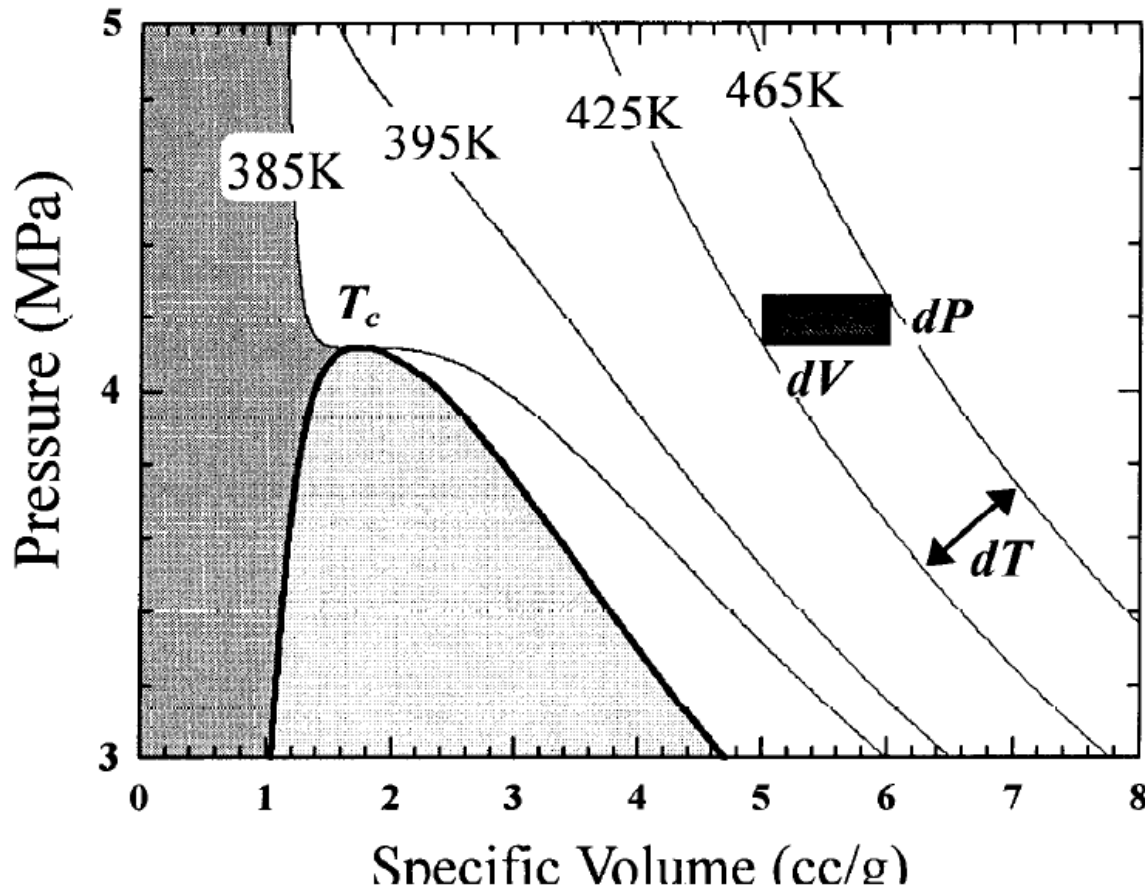

Fig. 5: PV diagram for Freon-12 (CCl_2F_2). The two phase region is light gray and the liquid is the darker gray region to the left. Isotherms are indicated by light lines and a typical dP/dV element is indicated by the rectangle.

$$\frac{\eta}{\eta_C} = \frac{dpdV}{dSdT}$$

$$1 + Z_{\text{th}}T = \frac{c_p}{c_V}$$

heat capacity at constant p or V

$$C_p \equiv T \left(\frac{\partial \mathcal{S}}{\partial T} \right)_p,$$

$$C_V \equiv T \left(\frac{\partial \mathcal{S}}{\partial T} \right)_V$$

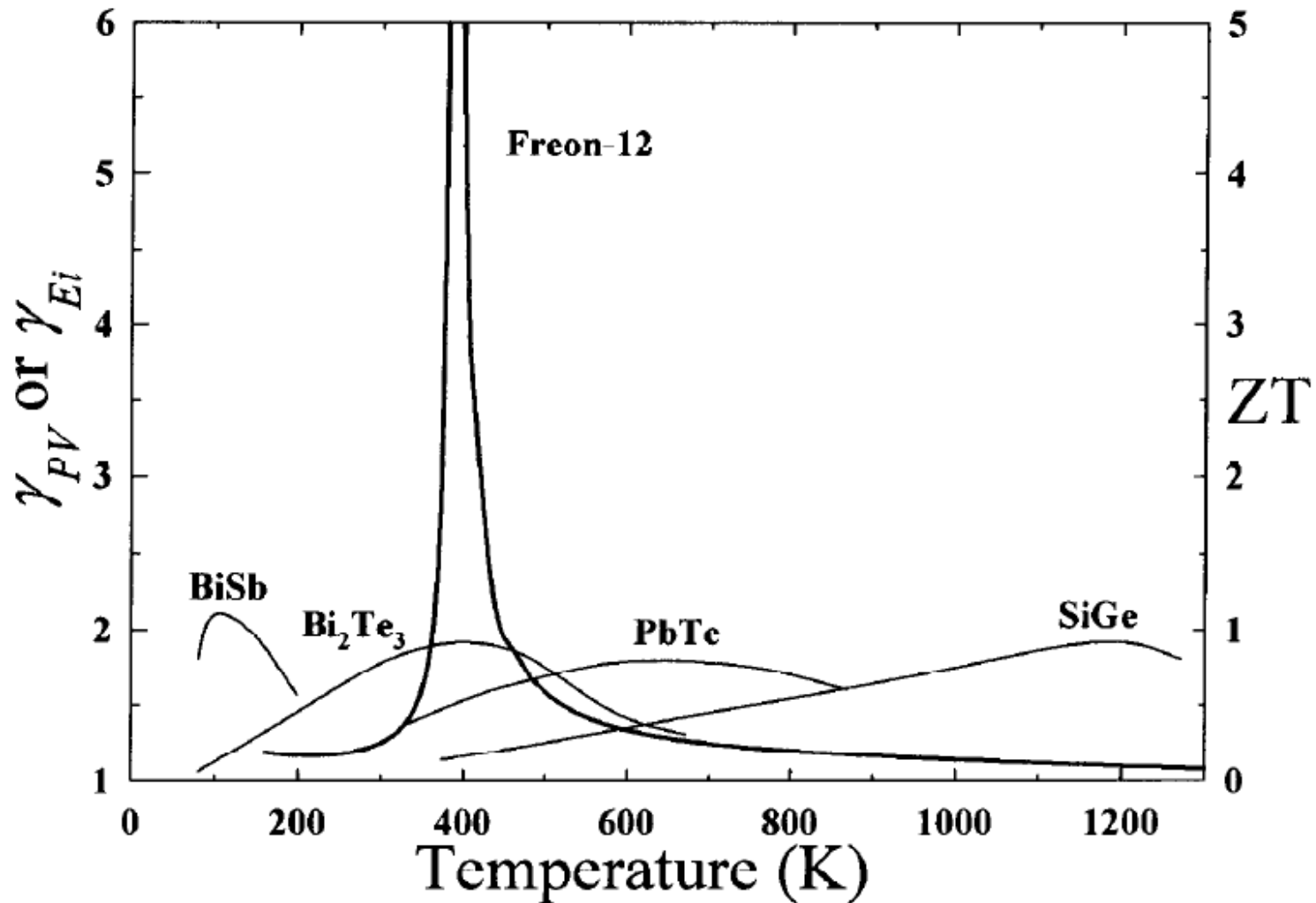
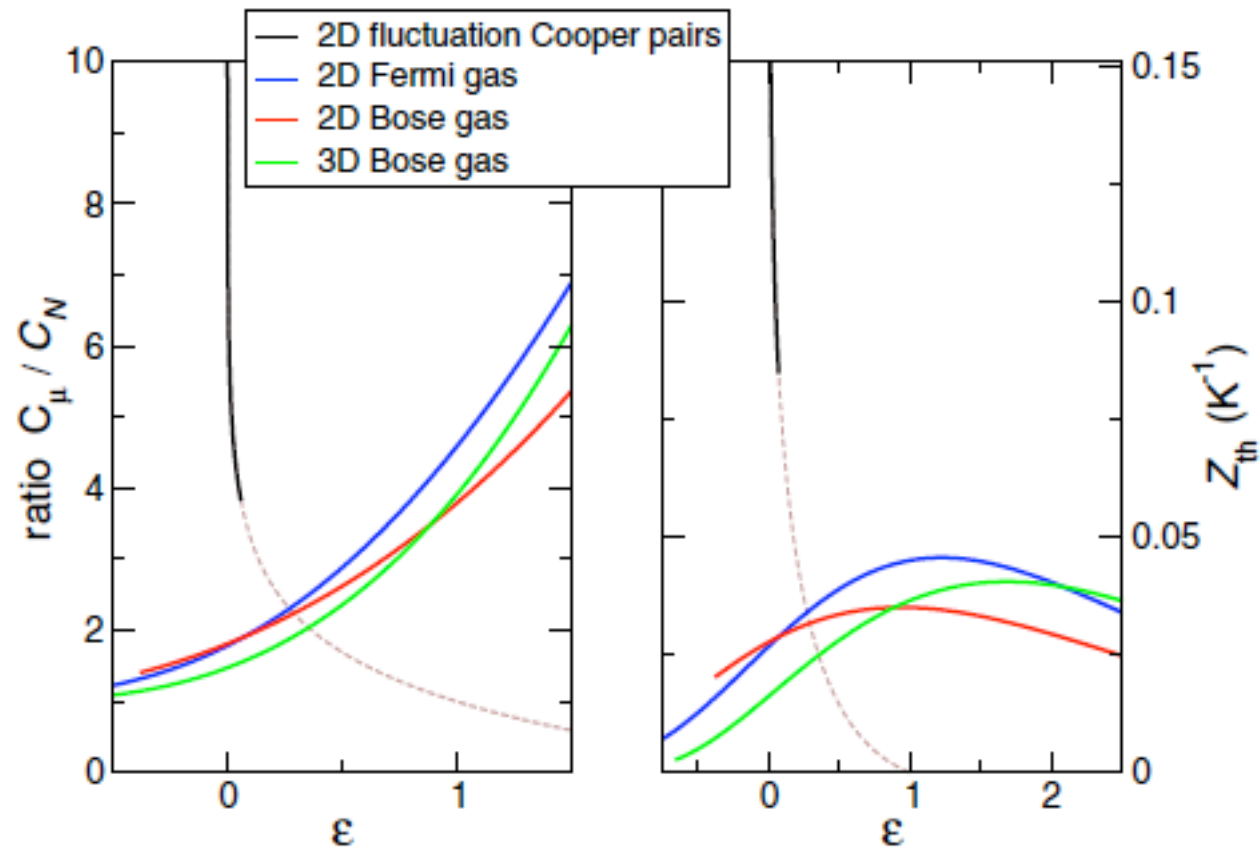

Fig. 4: Specific heat ratios, γ_{PV} for a *PV* system (Freon 12) and thermal conductivity ratios, $\gamma_{Ei}-1+ZT$, for selected n-type semiconductor alloys as a function of temperature.

(Vining, MRS Symp. 478, 3 (1997))



$$\epsilon = \ln T/T_c \approx (T - T_c)/T_c$$

(Ouerdane et al., PRB **91**, 100501 (2015))

Power-efficiency trade-off:

Is it possible to overcome the non-interacting bound?

Noninteracting systems: for $P/P_{\max} \ll 1$,

$$\eta(P) \leq \eta_{\max}(P) = \eta_C \left(1 - B_q \sqrt{\frac{T_R}{T_L} \frac{P}{P_{\max}}} \right),$$

$$B_q \approx 0.478 \quad (T_L > T_R)$$

Bound not favorable for power-efficiency trade-off; due to the fact that **delta-energy filtering** is the only mechanism to achieve Carnot for noninteracting systems

For **interacting systems** it is possible to achieve Carnot without delta-energy filtering

Momentum-conserving systems

Consider nonintegrable systems with a single relevant constant of motion, notably momentum conservation. From an argument based on Green-Kubo formula:

$$\sigma \sim \lambda_{ee} \sim \Lambda$$

$$S \sim \lambda_{eh}/\lambda_{ee} \sim \Lambda^0 \quad ZT = \frac{\sigma S^2}{\kappa} T \propto \Lambda^{1-\alpha} \rightarrow \infty \text{ when } \Lambda \rightarrow \infty$$

$$\kappa \sim \det \lambda / L_{ee} \sim \Lambda^\alpha$$

$(\alpha < 1)$

For integrable systems: $\det \lambda \propto \bar{\Lambda}^2$, $\kappa \propto \Lambda$, $ZT \propto \Lambda^0$

(G.B., G. Casati, J. Wang, PRL 110, 070604 (2013))

Example: 1D interacting classical gas

Consider a **one dimensional gas** of elastically colliding particles with **unequal masses: m, M**

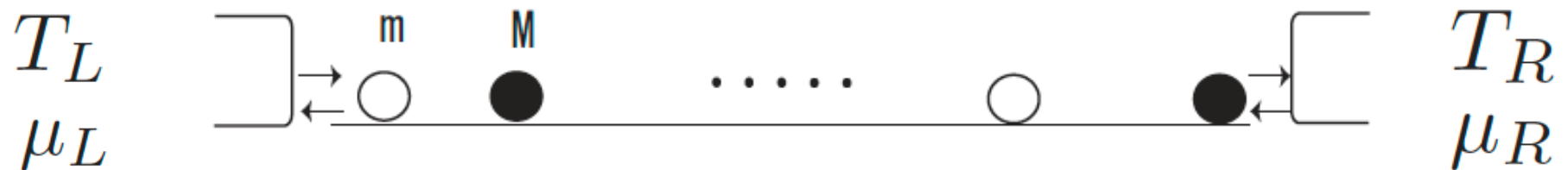

For $M = m$ (integrable model)

$$J_u = T_L \gamma_L - T_R \gamma_R \quad (J_u = J_q + \mu J_\rho)$$
$$J_\rho = \gamma_L - \gamma_R \quad ZT = 1 \text{ (at } \mu = 0)$$

For $M \neq m$ ZT depends on the system size

Quantum mechanics needed:

Relation between density and electrochemical potential

Reservoirs modeled as ideal (1D) gases

$$f_{\alpha}(v) = \sqrt{\frac{m}{2\pi k_B T_{\alpha}}} \exp\left(-\frac{mv^2}{2k_B T_{\alpha}}\right)$$

Maxwell-Boltzmann
distribution of
velocities

$$\gamma_{\alpha} = \rho_{\alpha} \int_0^{\infty} dv v f_{\alpha}(v) = \rho_{\alpha} \sqrt{\frac{k_B T_{\alpha}}{2\pi m}}$$

injection rates

$$\Xi_{\alpha} = \sum_{N=0}^{\infty} \frac{1}{N!} \left\{ \frac{\Lambda}{h} e^{\beta_{\alpha} \mu_{\alpha}} \int dv m \exp\left[-\beta_{\alpha} \left(\frac{1}{2} m v^2\right)\right] \right\}^N$$

grand partition
function

$$\langle N \rangle_{\alpha} = \frac{1}{\beta_{\alpha}} \frac{\partial}{\partial \mu_{\alpha}} \ln \Xi_{\alpha}, \quad \rho_{\alpha} = \frac{\langle N \rangle_{\alpha}}{\Lambda} = \frac{e^{\beta_{\alpha} \mu_{\alpha}} \sqrt{2\pi m k_B T_{\alpha}}}{h}$$

density

$$\mu_{\alpha} = k_B T_{\alpha} \ln(\lambda_{\alpha} \rho_{\alpha}), \quad \lambda_{\alpha} = \frac{h}{\sqrt{2\pi m k_B T_{\alpha}}}$$

de Broglie thermal
wave length

Carnot efficiency at the thermodynamic limit

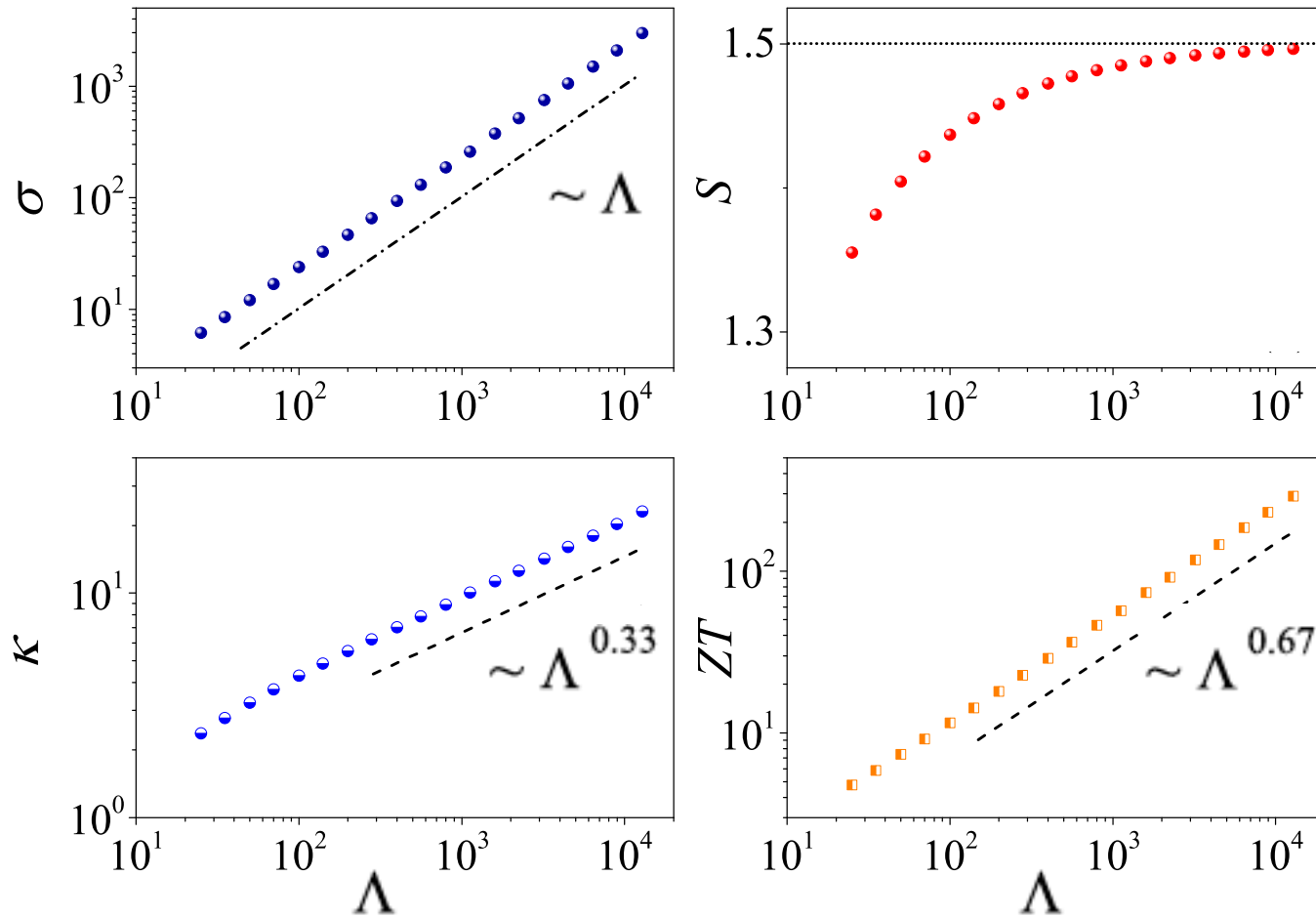

**Anomalous
thermal transport**

$$ZT = \frac{\sigma S^2}{k} T$$

ZT diverges
increasing the systems size

[R. Luo, G. B., G. Casati, J. Wang, PRL **121**, 080602 (2018)]

Delta-energy filtering mechanism?

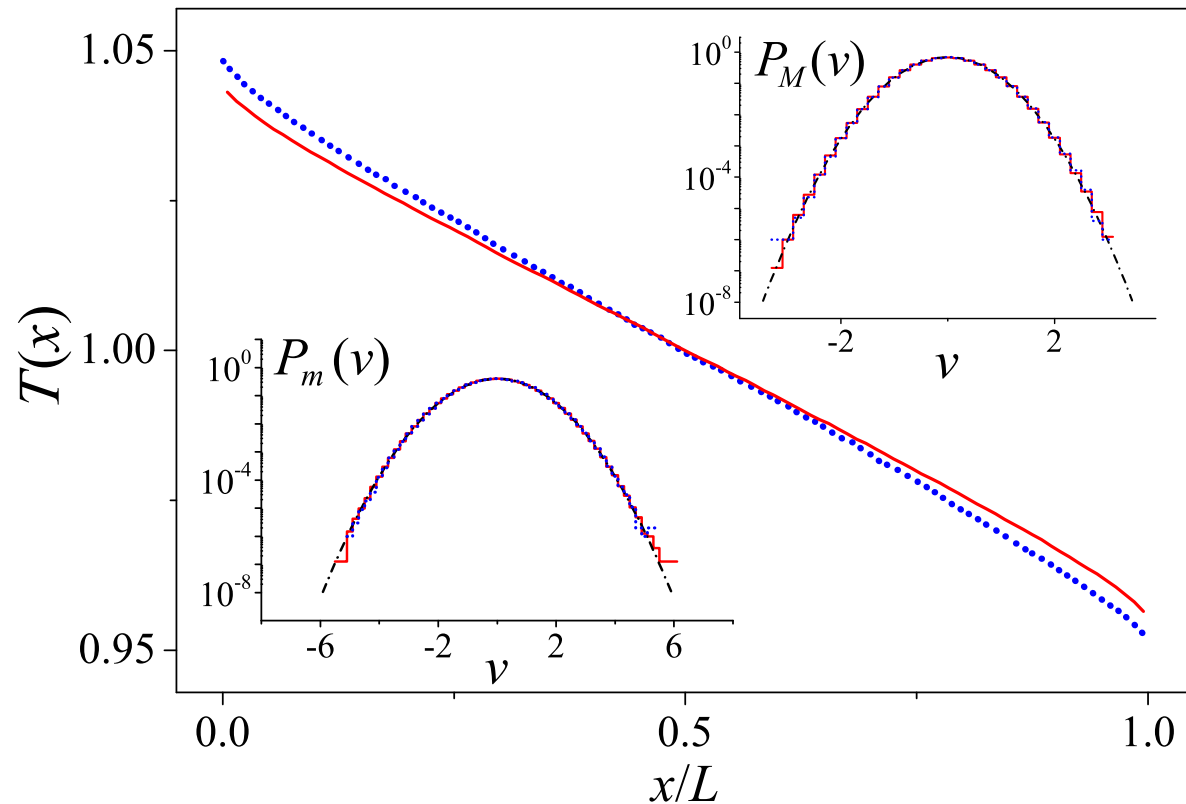

A mechanism for achieving Carnot **different from delta-energy filtering** is needed

Validity of linear response

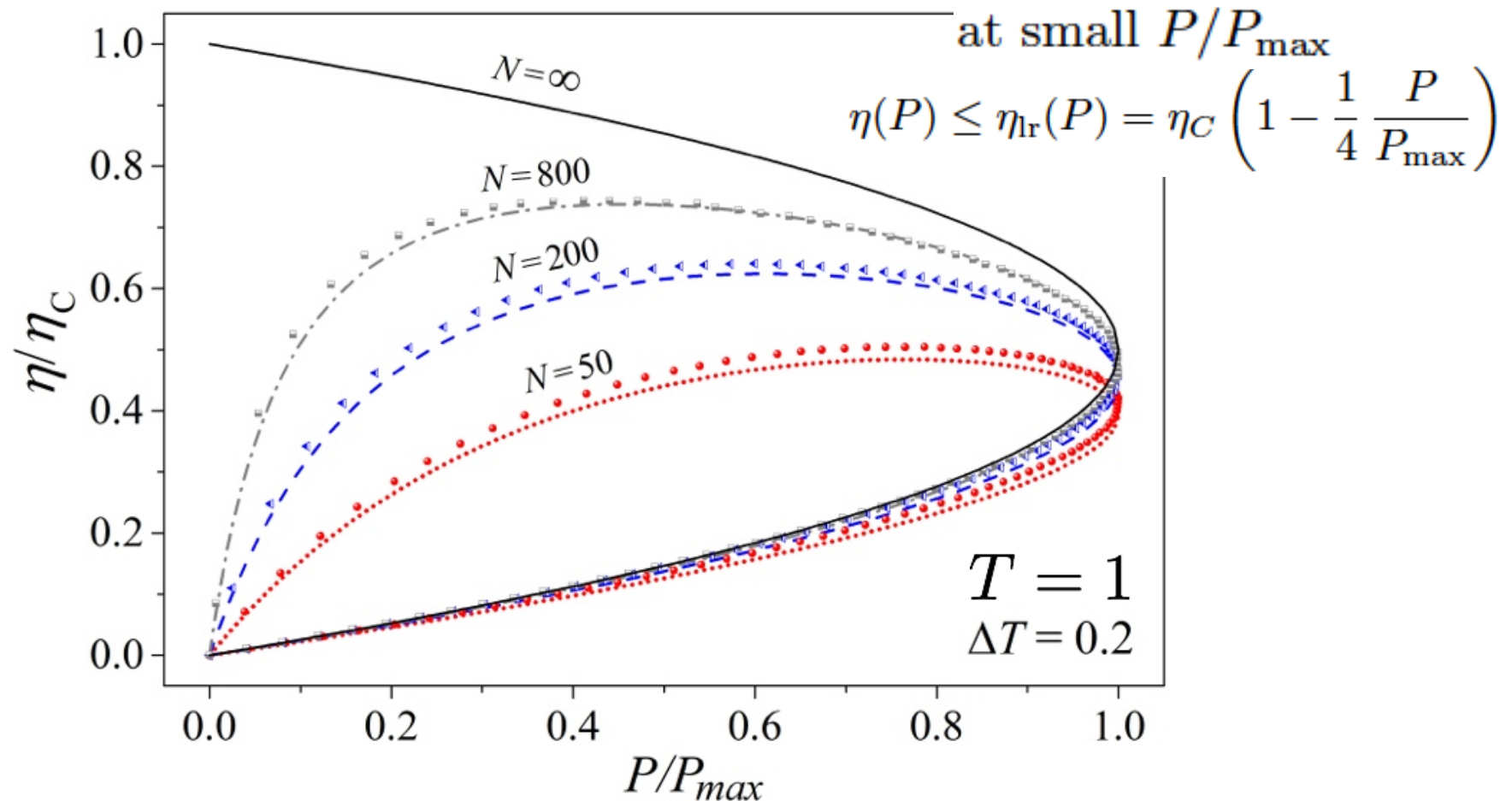

The agreement with linear response improves with N
(∇T decreases as the system size increases)

Non-interacting classical bound (but quantum mechanics needed)

$$J_\rho = \gamma_L \int_0^\infty d\epsilon u_L(\epsilon) \mathcal{T}(\epsilon) - \gamma_R \int_0^\infty d\epsilon u_R(\epsilon) \mathcal{T}(\epsilon), \quad u_\alpha(\epsilon) = \beta_\alpha e^{-\beta_\alpha \epsilon}$$

$$J_e = \frac{e}{h} \int_0^\infty dE [f_L(E) - f_R(E)] \tau(E) \quad \text{charge current}$$

$$J_{h,\alpha} = \frac{1}{h} \int_0^\infty dE (E - \mu_\alpha) [f_L(E) - f_R(E)] \tau(E) \quad \text{heat current}$$

$$f_\alpha(E) = e^{-\beta_\alpha (E - \mu_\alpha)} \quad \text{Maxwell-Boltzmann distribution}$$

$$0 \leq \tau(E) \leq 1 \quad (\text{in 1D})$$

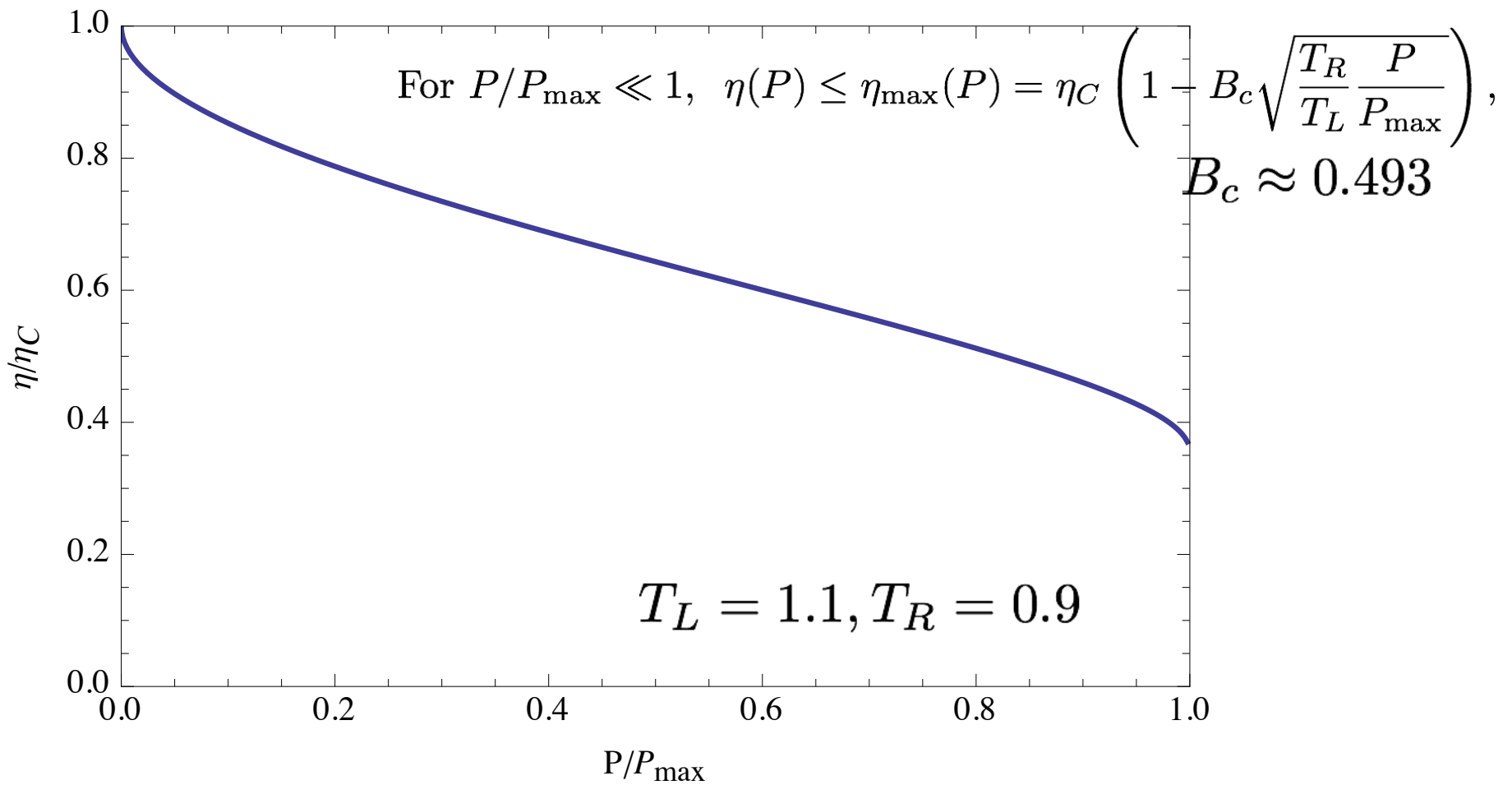

$$P \leq P_{\max} = A_c \frac{\pi^2}{h} k_B^2 (\Delta T)^2, \quad A_c \approx 0.0373$$

Overcoming the non-interacting bound

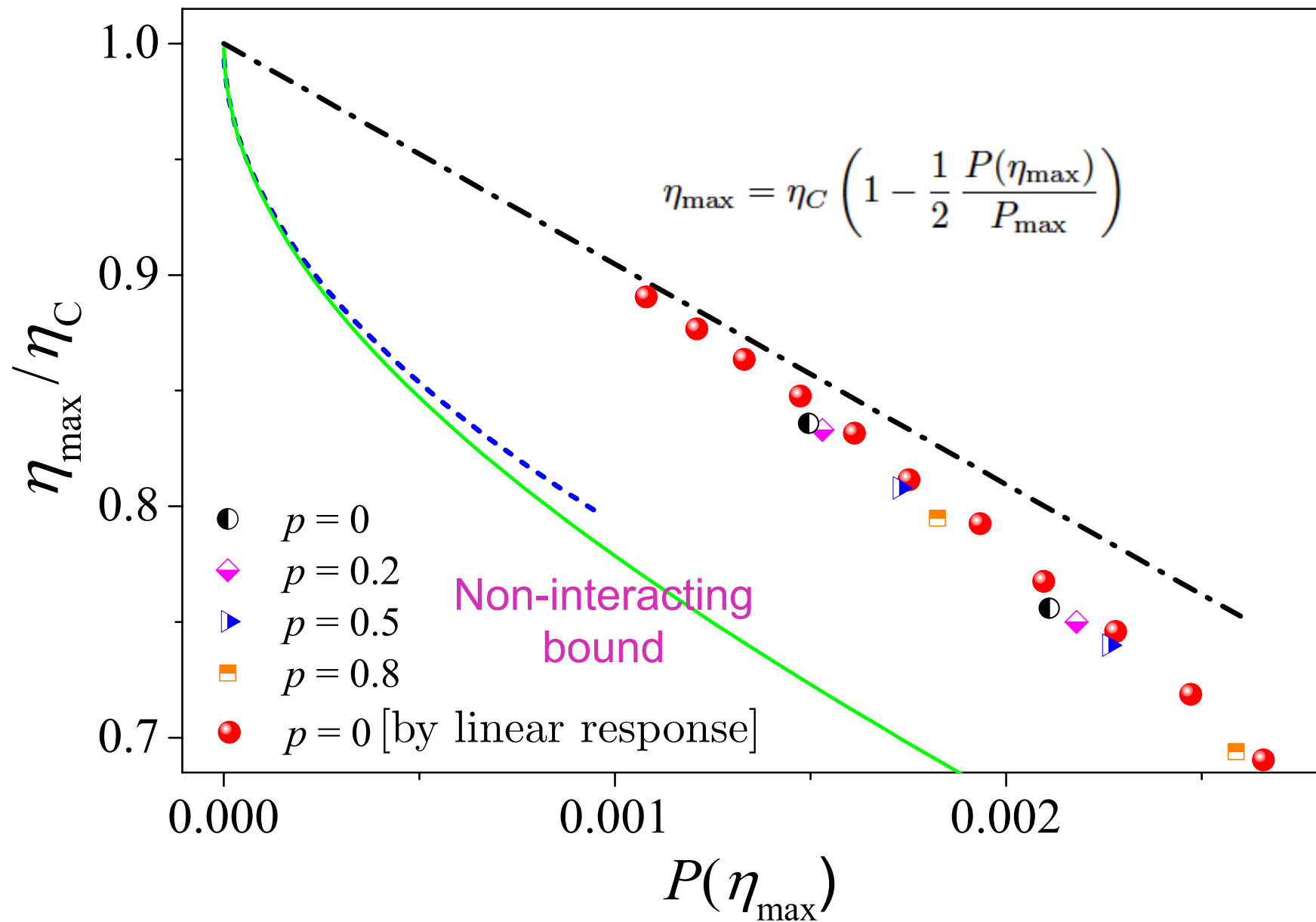

Multiparticle collision dynamics (Kapral model) in 2D

Streaming step: free propagation during a time τ

$$\vec{r}_i \longrightarrow \vec{r}_i + \vec{v}_i \tau$$

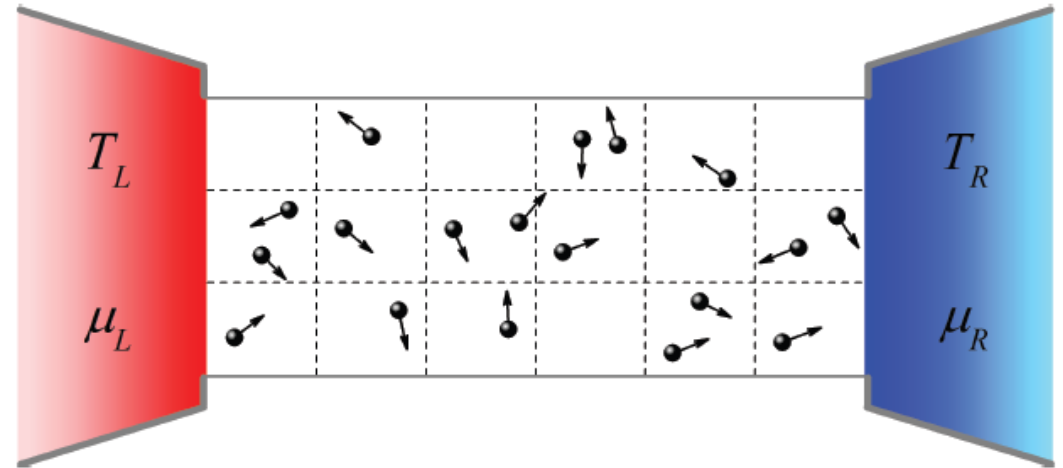

Collision step: random rotations of the velocities of the particles in cells of linear size a with respect to the center of mass velocity:

$$\vec{v}_i \longrightarrow \vec{V}_{\text{CM}} + \hat{\mathcal{R}}^{\pm\alpha} \left(\vec{v}_i - \vec{V}_{\text{CM}} \right)$$

Momentum is conserved

Overcoming the (2D) non-interacting bound

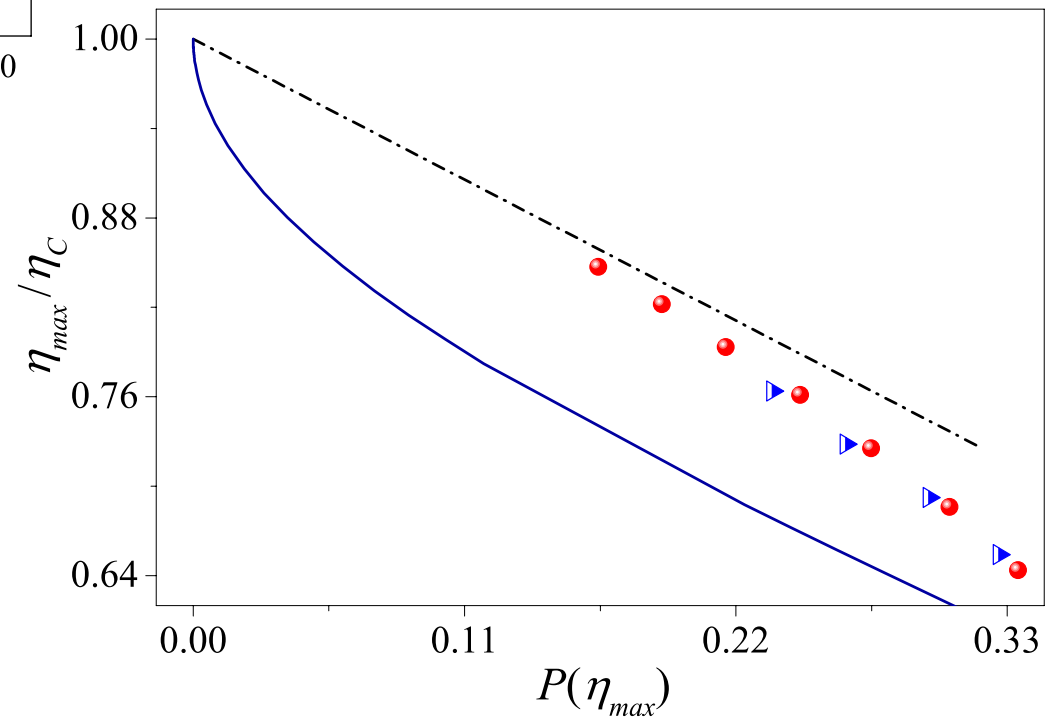
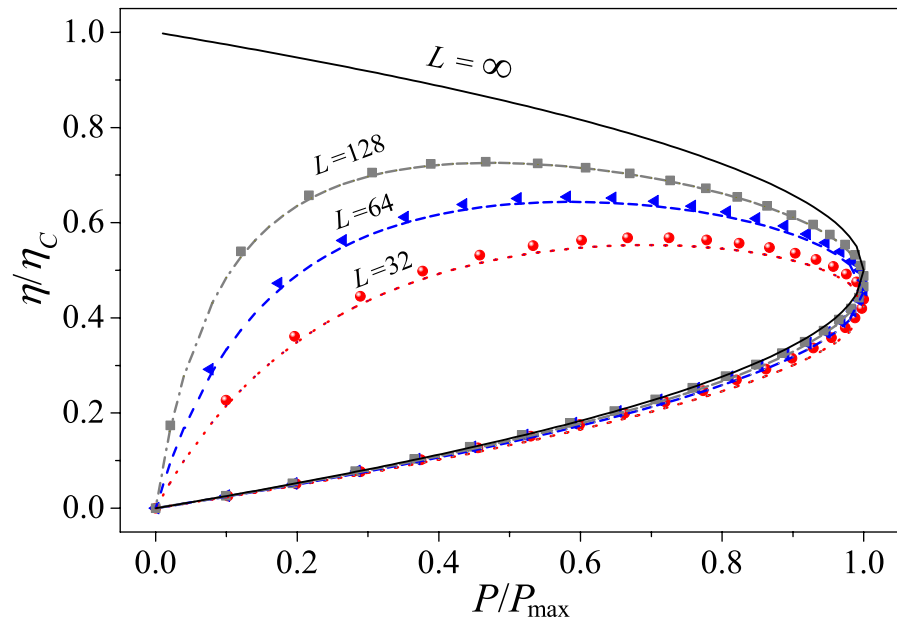

Results can be extended to cooling

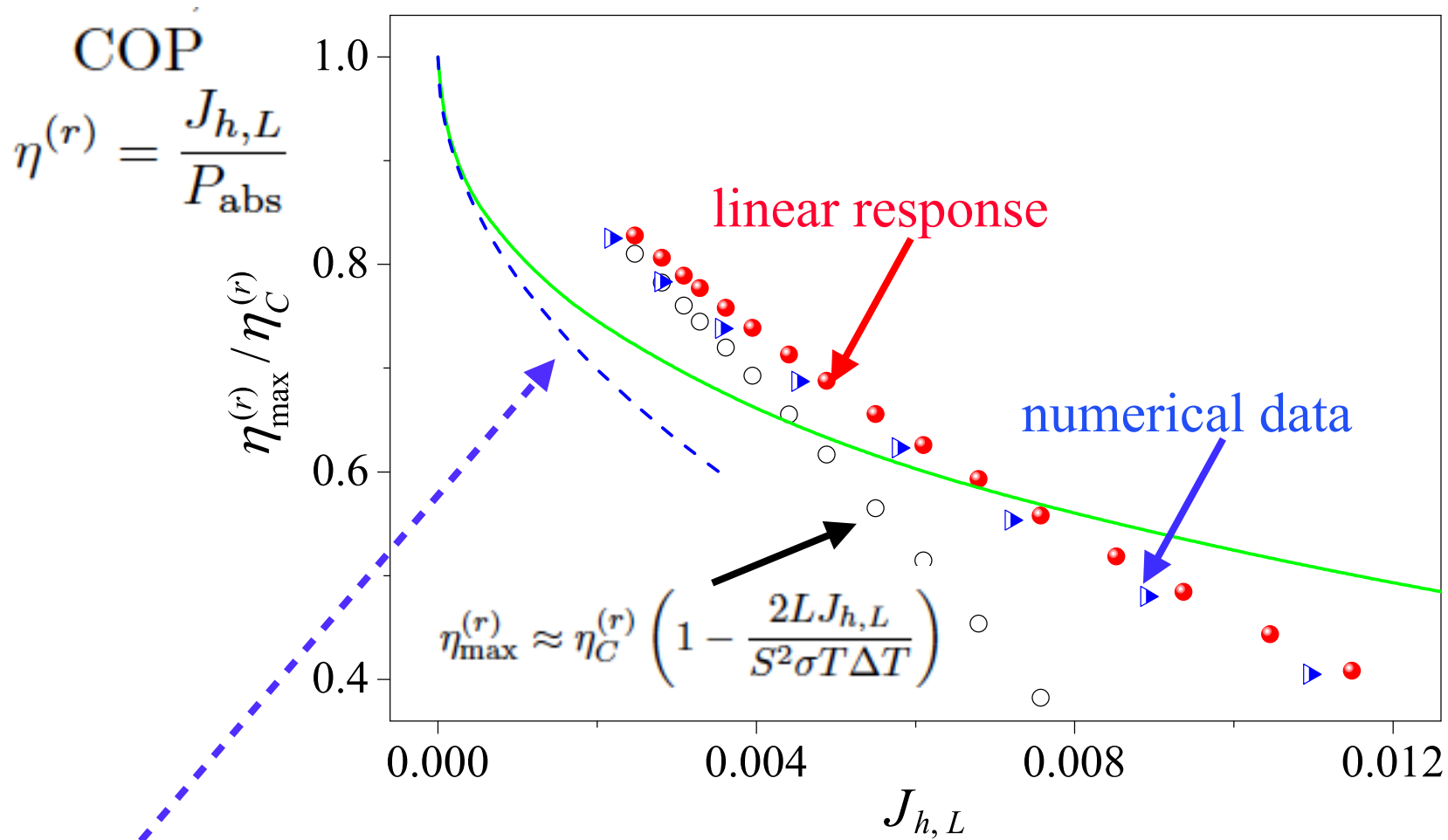

$$\eta^{(r)} \leq \eta_{\text{max}}^{(r,\text{st})}(J_{h,L}) \approx \eta_C^{(r)} \left(1 - C \sqrt{\frac{T_R}{T_R - T_L} \frac{J_{h,L}}{(J_{h,L})_{\text{max}}^{(\text{st})}}} \right), \quad (J_{h,L})_{\text{max}}^{(\text{st})} = \frac{k_B^2 T_L^2}{h}$$

$C \approx 0.813$

Applications for cold atoms?

Breakdown of the Wiedemann–Franz law in a unitary Fermi gas

Dominik Husmann^a, Martin Lebrat^a, Samuel Häusler^a, Jean-Philippe Brantut^b, Laura Corman^{a,1}, and Tilman Esslinger^a

We report on coupled heat and particle transport measurements through a quantum point contact (QPC) connecting two reservoirs of resonantly interacting, finite temperature Fermi gases. After heating one of them, we observe a particle current flowing from cold to hot. We monitor the temperature evolution of the reservoirs and find that the system evolves after an initial response into a nonequilibrium steady state with finite temperature and chemical potential differences across the QPC. In this state any relaxation in the form of heat and particle currents vanishes. From our measurements we extract the transport coefficients of the QPC and deduce a Lorenz number violating the Wiedemann–Franz law by one order of magnitude, a characteristic persisting even for a wide contact. In contrast, the Seebeck coefficient takes a value close to that expected for a noninteracting Fermi gas and shows a smooth decrease as the atom density close to the QPC is increased beyond the superfluid transition. Our work represents a fermionic analog of the fountain effect observed with superfluid helium and poses challenges for microscopic modeling of the finite temperature dynamics of the unitary Fermi gas.

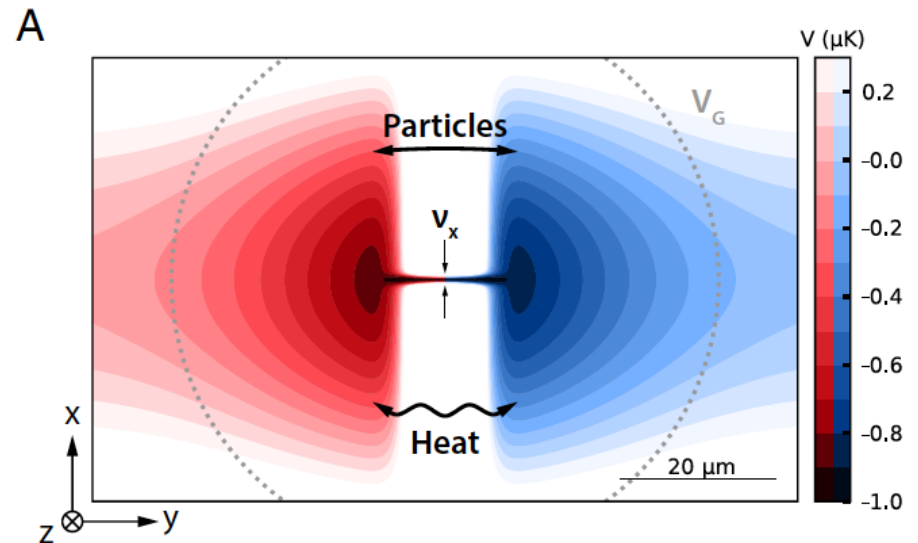

Power-efficiency trade-off at the verge of phase transitions

For heat engines described as Markov processes:

$$P \leq A(\eta_C - \eta)$$

[N. Shiraishi, K. Saito, H. Tasaki, PRL **117**, 190601 (2016)]

For a working substance at a critical point:

$$(\eta - \eta_C) \sim N^{-a} \rightarrow 0 \text{ (with } a > 0), \quad P \sim N$$

[M. Campisi, R. Fazio, Nature Comm. **7**, 11895 (2016); see also
Allahverdyan et al., PRL **111**, 050601 (2013)]

Results compatible only with diverging amplitude A
when approaching the Carnot efficiency

Power-efficiency-fluctuations trade-off

For **classical** Markovian dynamics on a finite set of states and overdamped Langevin dynamics, trade-off between power, efficiency, and constancy for **steady-state engines**:

$$P \frac{\eta}{\eta_C - \eta} \frac{T_c}{\Delta_P} \leq \frac{1}{2} \quad \Delta_P \equiv \lim_{t \rightarrow \infty} \langle (P(t) - P)^2 \rangle t$$

[P. Pietzonka, U. Seifert, PRL **120**, 190602 (2018)]

Bound violated in **quantum** mechanics, e.g. for resonant tunnelling transport (noninteracting system), but not close to Carnot efficiency. The problem for interacting systems is open.

[J. Liu, D. Segal, PRE **99**, 062141 (2019)]

Carnot efficiency at finite power with broken time-reversal symmetry?

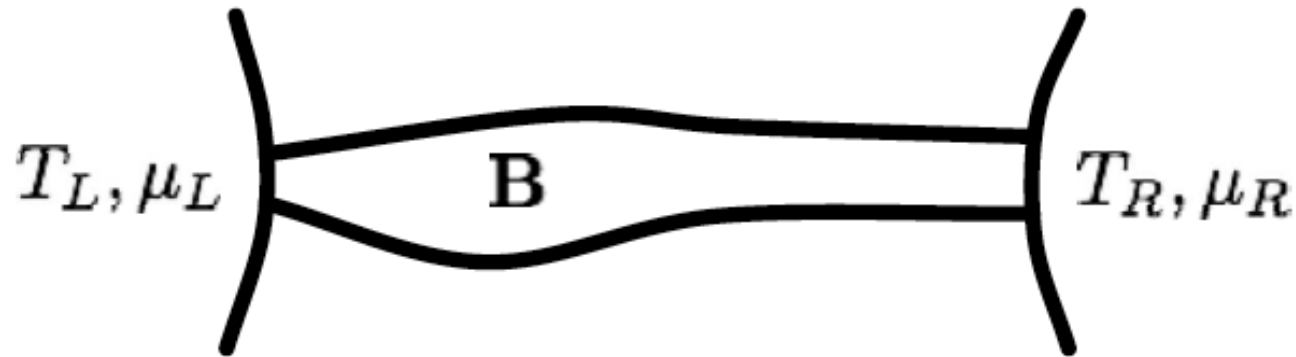

$$\left\{ \begin{array}{l} J_e = L_{ee}(\mathbf{B})\mathcal{F}_e + L_{eh}(\mathbf{B})\mathcal{F}_h \\ J_h = L_{he}(\mathbf{B})\mathcal{F}_e + L_{hh}(\mathbf{B})\mathcal{F}_h \end{array} \right. \quad \begin{array}{l} \mathcal{F}_e = \Delta V/T \quad (\Delta V = \Delta\mu/e) \\ \mathcal{F}_h = \Delta T/T^2 \end{array}$$

\mathbf{B} applied magnetic field or any
parameter breaking time-reversibility
such as the Coriolis force, etc.

$$\Delta\mu = \mu_L - \mu_R$$

$$\Delta T = T_L - T_R$$

(we assume $T_L > T_R$, $\mu_L < \mu_R$)

Constraints from thermodynamics

POSITIVITY OF THE ENTROPY PRODUCTION:

$$\mathcal{P} = \mathcal{F}_e J_e + \mathcal{F}_h J_h \geq 0 \quad \Rightarrow \quad \begin{aligned} L_{ee} &\geq 0 \\ L_{hh} &\geq 0 \\ L_{ee} L_{hh} - \frac{1}{4} (L_{eh} + L_{he})^2 &\geq 0 \end{aligned}$$

ONSAGER-CASIMIR RELATIONS:

$$L_{ij}(\mathbf{B}) = L_{ji}(-\mathbf{B}) \quad \Rightarrow \quad \begin{aligned} G(\mathbf{B}) &= G(-\mathbf{B}) \\ K(\mathbf{B}) &= K(-\mathbf{B}) \end{aligned}$$

in general, $S(\mathbf{B}) \neq S(-\mathbf{B})$

Both maximum efficiency and efficiency at maximum power depend on two parameters

$$x = \frac{L_{eh}}{L_{he}} = \frac{S(\mathbf{B})}{S(-\mathbf{B})}$$

$$y = \frac{L_{eh}L_{he}}{\det \mathbf{L}} = \frac{G(\mathbf{B})S(\mathbf{B})S(-\mathbf{B})}{K(\mathbf{B})} T$$

$$\eta(P_{\max}) = \frac{\eta_C}{2} \frac{xy}{2+y} \quad \eta_{\max} = \eta_C x \frac{\sqrt{y+1}-1}{\sqrt{y+1}+1}$$

At $B = 0$ there is time-reversibility and:

asymmetry parameter $x = 1$

the efficiency only depends on $y(x = 1) = ZT$

$$L_{\rho\rho}L_{qq} - \frac{1}{4}(L_{\rho q} + L_{q\rho})^2 \geq 0 \Rightarrow$$

$$\begin{cases} h(x) \leq y \leq 0 & \text{if } x < 0 \\ 0 \leq y \leq h(x) & \text{if } x > 0 \end{cases}$$

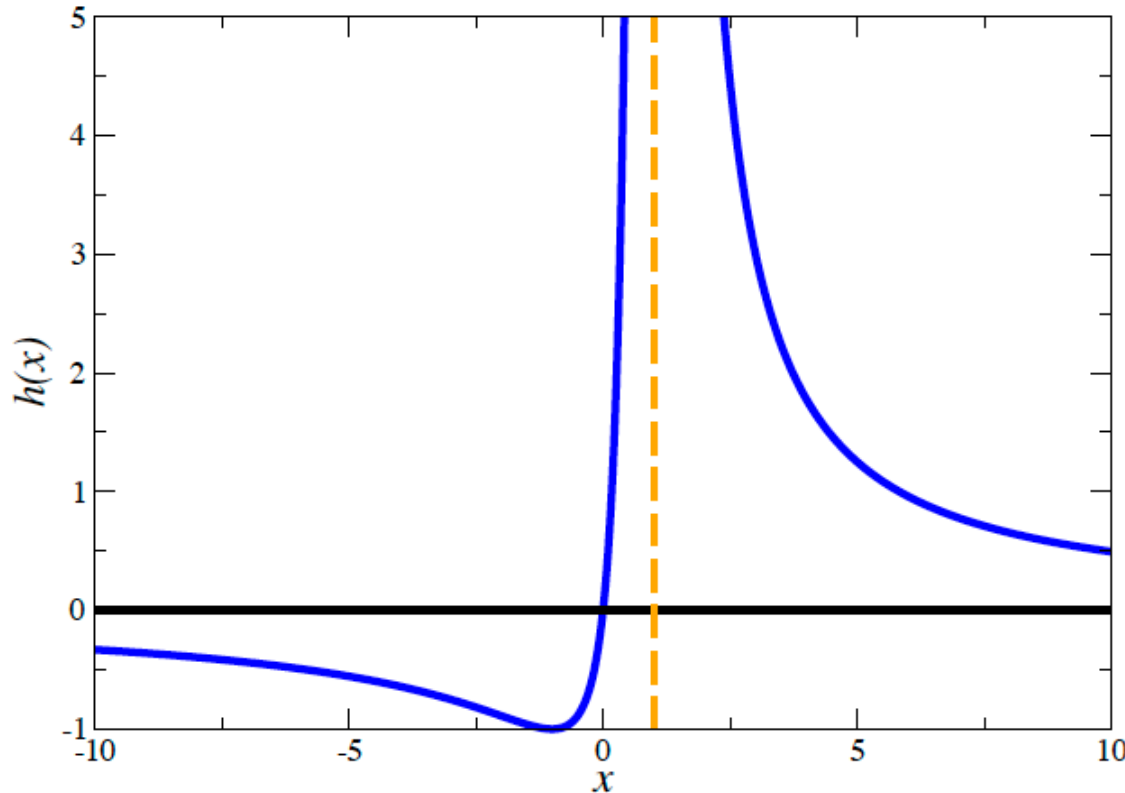

$$h(x) = 4x / (x - 1)^2$$

maximum efficiencies
achieved for $y = h(x)$

$$\bar{\eta}(P_{\max}) = \eta_C \frac{x^2}{x^2 + 1}, \quad \bar{\eta}_{\max} = \begin{cases} \eta_C x^2 & \text{if } |x| \leq 1, \\ \eta_C & \text{if } |x| \geq 1. \end{cases}$$

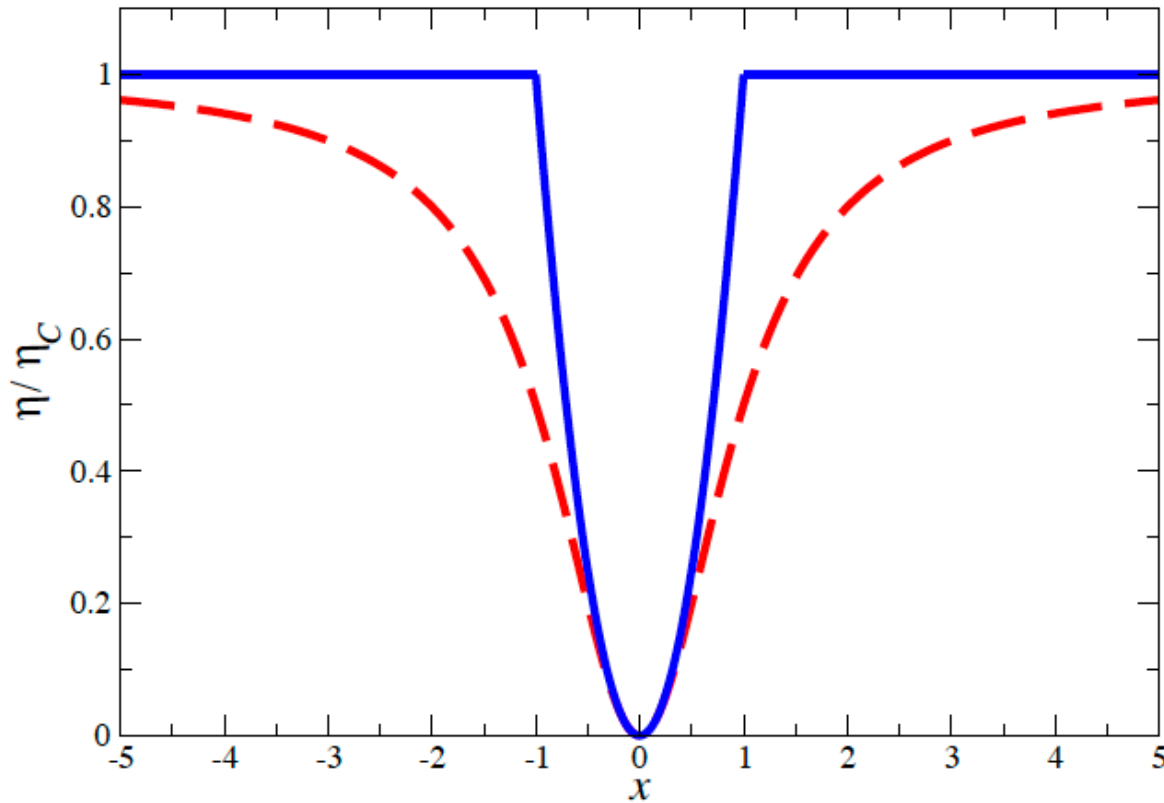

The CA limit can be overcome within linear response

When $|x|$ is large the figure of merit y required to get Carnot efficiency becomes small

Carnot efficiency could be obtained far from the tight coupling condition

[G..B., K. Saito, G. Casati, PRL **106**, 230602 (2011)]

Output power at maximum efficiency

$$P(\bar{\eta}_{\max}) = \frac{\bar{\eta}_{\max}}{4} \frac{|L_{eh}^2 - L_{he}^2|}{L_{ee}} \mathcal{F}_h$$

When time-reversibility is broken, within linear response it is not forbidden from the second law to have simultaneously Carnot efficiency and non-zero power.

Terms of higher order in the entropy production, beyond linear response, will generally be non-zero. However, irrespective how close we are to the Carnot efficiency, we could find small enough forces such that the linear theory holds.

Reversible part of the currents

$$J_i^{\text{rev}} = \sum_{j=e,h} \frac{L_{ij} - L_{ji}}{2} \mathcal{F}_j$$
$$J_i^{\text{irr}} = \sum_{j=e,h} \frac{L_{ij} + L_{ji}}{2} \mathcal{F}_j$$

The reversible part of the currents does not contribute to entropy production

$$\dot{\mathcal{S}} = \mathcal{F}_e J_e + \mathcal{F}_h J_h = J_e^{\text{irr}} \mathcal{F}_e + J_h^{\text{irr}} \mathcal{F}_h$$

Possibility of dissipationless transport?

[K.. Brandner, K. Saito, U. Seifert, PRL **110**, 070603 (2013)]

How to obtain asymmetry in the Seebeck coefficient?

For non-interacting systems, due to the symmetry properties of the scattering matrix $\Rightarrow S(\mathbf{B}) = S(-\mathbf{B})$

This symmetry does not apply when electron-phonon and electron-electron interactions are taken into account

Let us consider the case of partially coherent transport, with inelastic processes simulated by “conceptual probes” mimicking inelastic scattering (Buttiker, 1988).

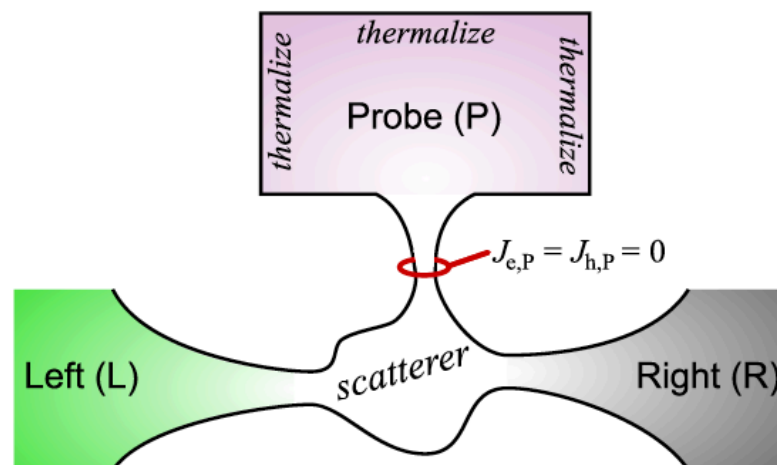

Non-interacting three-terminal model

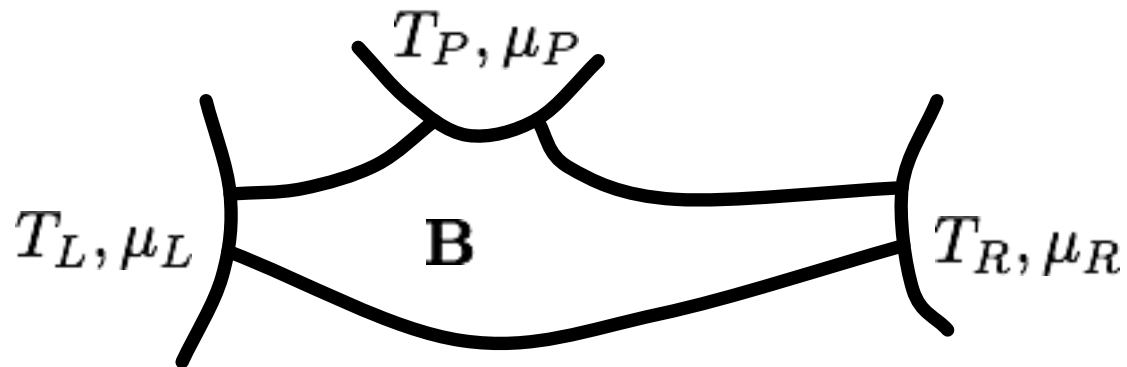

P probe reservoir

$$T_L = T + \Delta T, \quad T_R = T$$

$$\mu_L = \mu + \Delta\mu, \quad \mu_R = \mu$$

$$T_P = T + \Delta T_P$$

$$\mu_P = \mu + \Delta\mu$$

Charge and energy conservation:

$$\sum_k J_{e,k} = 0, \quad \sum_k J_{u,k} = 0 \quad (J_{h,k} = J_{u,k} - (\mu/e)J_{e,k})$$

Entropy production (linear response):

$$\dot{\mathcal{S}} = {}^t \mathcal{F} \mathbf{J} = \sum_{i=1}^4 J_i \mathcal{F}_i$$

$${}^t \mathbf{J} = (J_{eL}, J_{hL}, J_{eP}, J_{hP})$$

$${}^t \mathcal{F} = \left(\frac{\Delta\mu}{eT}, \frac{\Delta T}{T^2}, \frac{\Delta\mu_P}{eT}, \frac{\Delta T_P}{T^2} \right)$$

Three-terminal Onsager matrix

Equation connecting fluxes and thermodynamic forces:

$$\mathbf{J} = \mathbf{L}\mathcal{F}$$

\mathbf{L} is a 4×4 Onsager matrix

In block-matrix form:

$$\begin{pmatrix} \mathbf{J}_\alpha \\ \mathbf{J}_\beta \end{pmatrix} = \begin{pmatrix} \mathbf{L}_{\alpha\alpha} & \mathbf{L}_{\alpha\beta} \\ \mathbf{L}_{\beta\alpha} & \mathbf{L}_{\beta\beta} \end{pmatrix} \begin{pmatrix} \mathcal{F}_\alpha \\ \mathcal{F}_\beta \end{pmatrix}$$

Zero-particle and heat current condition through the probe terminal:

$$\mathbf{J}_\beta = (J_3, J_4) = 0 \quad \Rightarrow \quad \mathcal{F}_\beta = -\mathbf{L}_{\beta\beta}^{-1} \mathbf{L}_{\beta\alpha} \mathcal{F}_\alpha$$

Two-terminal Onsager matrix for partially coherent transport

Reduction to 2x2 Onsager matrix when the third terminal is a probe terminal mimicking inelastic scattering

$$\mathbf{J}_\alpha = \mathbf{L}' \mathcal{F}_\alpha, \quad \mathbf{L}' \equiv \mathbf{L}_{\alpha\alpha} - \mathbf{L}_{\alpha\beta} \mathbf{L}_{\beta\beta}^{-1} \mathbf{L}_{\beta\alpha}.$$

$$\begin{pmatrix} J_1 \\ J_2 \end{pmatrix} = \begin{pmatrix} L'_{11} & L'_{12} \\ L'_{21} & L'_{22} \end{pmatrix} \begin{pmatrix} \mathcal{F}_1 \\ \mathcal{F}_2 \end{pmatrix}$$

\mathbf{L}' is the two-terminal Onsager matrix for partially coherent transport

The Seebeck coefficient is not bounded to be symmetric in \mathbf{B} (for asymmetric structures)

First-principle exact calculation within the Landauer-Büttiker approach

Bilinear Hamiltonian $H = H_S + H_R + H_C$

Tight binding N -site Hamiltonian

$$H_S = \sum_{n,n'=1}^N H_{nn'} c_n^\dagger c'_n$$

Reservoirs (ideal Fermi gases): $H_R = \sum_{k,q} E_q c_{kq}^\dagger c_{kq}$

Coupling (tunneling) Hamiltonian

$$H_C = \sum_{k,q} (t_{kq} c_{kq}^\dagger c_{i_k} + t_{kq}^* c_{kq} c_{i_k}^\dagger)$$

Charge and heat current from the left terminal

$$J_1 = \frac{e}{h} \int_{-\infty}^{\infty} dE \sum_k [\tau_{kL}(E) f_L(E) - \tau_{Lk}(E) f_k(E)],$$

$$J_2 = \frac{1}{h} \int_{-\infty}^{\infty} dE (E - \mu_L) \sum_k [\tau_{kL}(E) f_L(E) - \tau_{Lk}(E) f_k(E)],$$

$$f_k(E) = \{\exp[(E - \mu_k)/k_B T_k] + 1\}^{-1} \text{ Fermi function}$$

τ_{kl} transmission probability from terminal l to terminal k

$$J_3 = J_1(L \rightarrow P), \quad J_4 = J_2(L \rightarrow P)$$

Onsager coefficients from linear response expansion of the currents

Transmission probabilities:

$$\mathcal{T}_{pq} = \text{Tr}[\Gamma_p(E)G(E)\Gamma_q(E)G^\dagger(E)]$$

Broadening functions $\Gamma_k(E) \equiv i[\Sigma_k(E) - \Sigma_k^\dagger(E)]$

Self-energies Σ_k

Retarded system's Green function

$$G(E) \equiv [E - H_S - \sum_k \Sigma_k(E)]^{-1}$$

Illustrative three-dot example

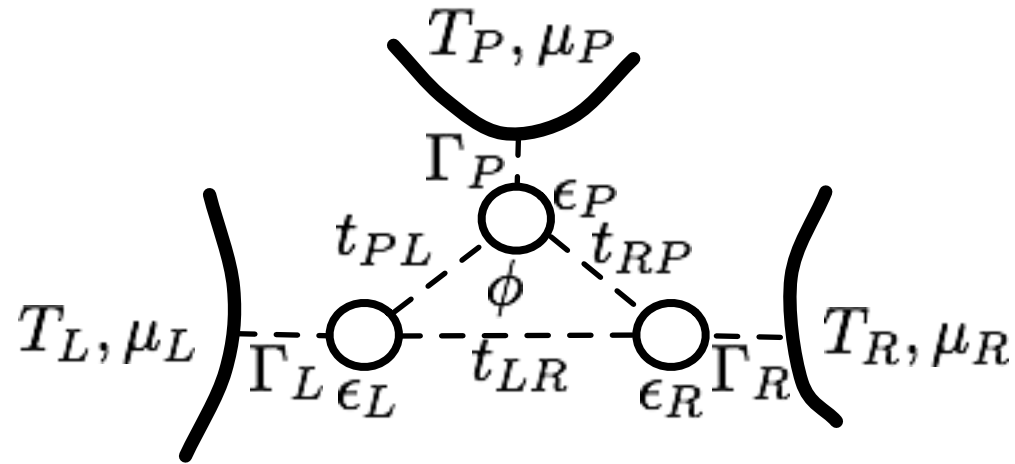

$$H_S = \sum_k \epsilon_k c_k^\dagger c_k + (t_{LR} c_R^\dagger c_L e^{i\phi/3} + t_{RP} c_P^\dagger c_R e^{i\phi/3} + t_{PL} c_L^\dagger c_P e^{i\phi/3} + \text{H.c.})$$

Asymmetric structure, e.g.. $\epsilon_L \neq \epsilon_R$

Asymmetric Seebeck coefficient

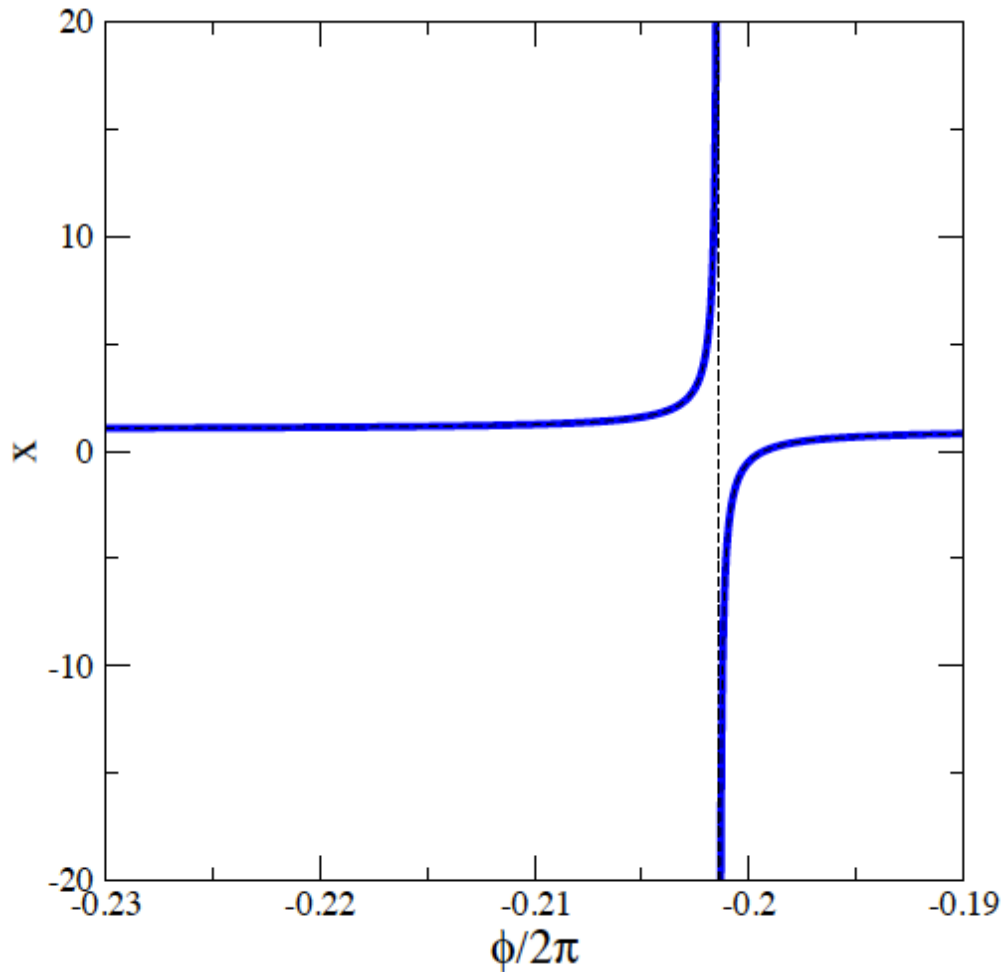

$$x(\phi) = \frac{L'_{12}(\phi)}{L'_{21}(\phi)} = \frac{S(\phi)}{S(-\phi)} \neq 1$$

[K. Saito, G. B., G. Casati, T. Prosen, PRB **84**, 201306(R) (2011)]

[see also D. Sánchez, L. Serra, PRB **84**, 201307(R) (2011)]

Transmission windows model

$$\sum_i \tau_{ij}(E) = \sum_j \tau_{ij}(E) = 1$$

The Curzon-Ahlborn limit can be overcome (within linear response)

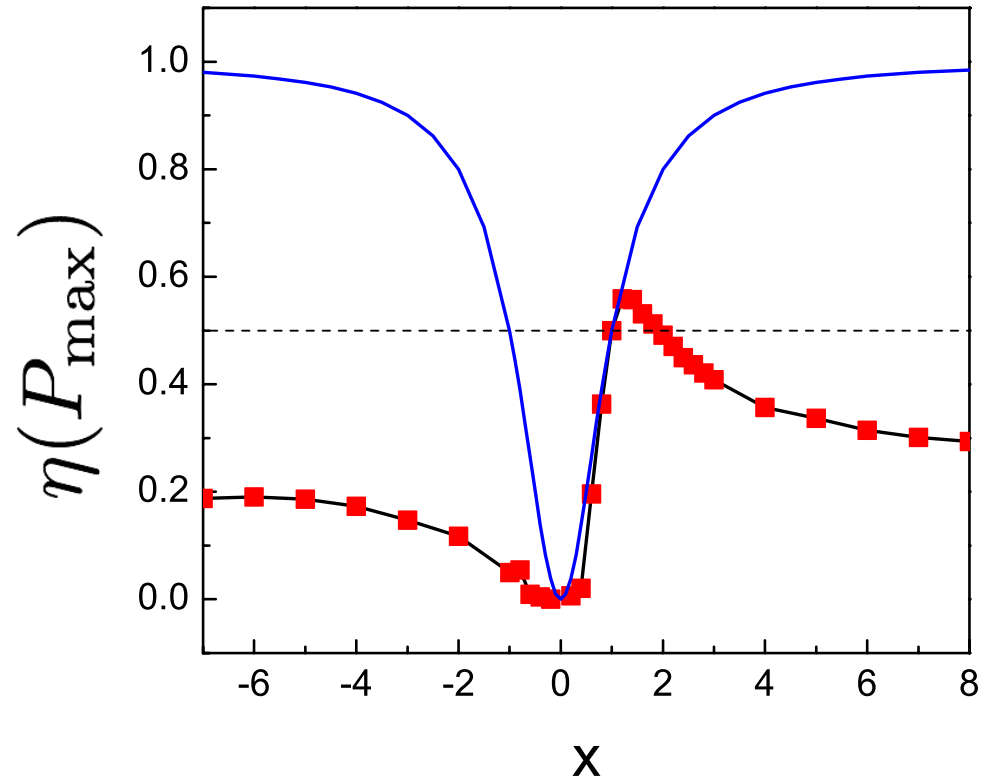
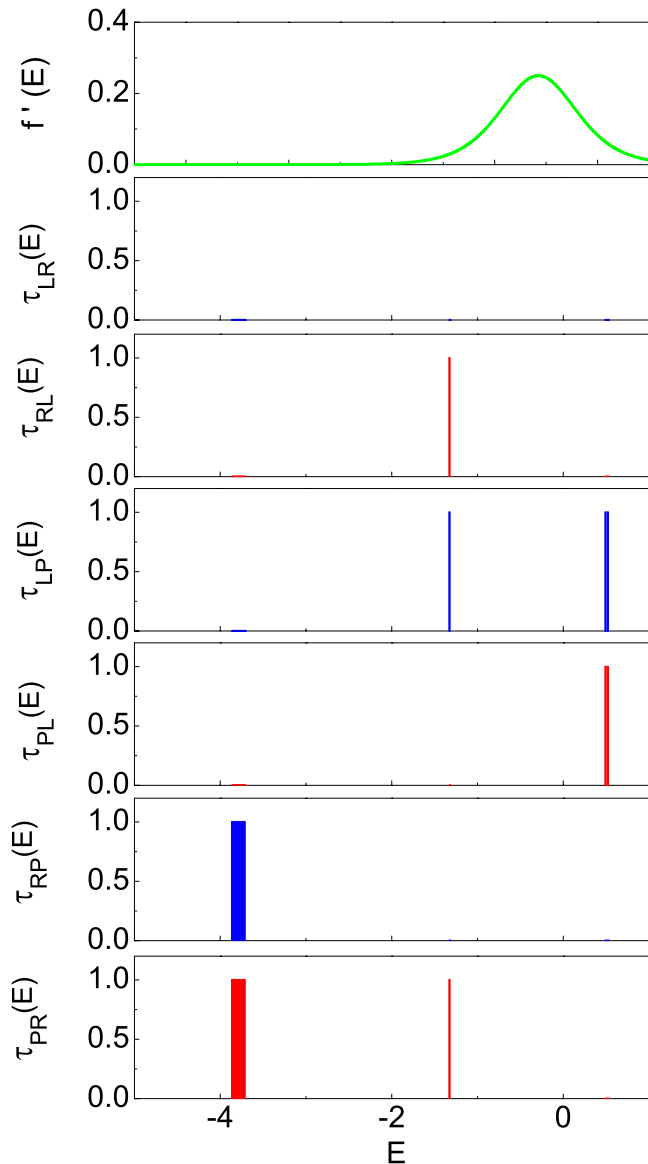

[V.. Balachandran, G. B., G. Casati, PRB **87**, 165419 (2013);
se also M. Horvat, T. Prosen, G. B., G. Casati,
PRE **86**, 052102 (2012)]

Saturation of bounds from the unitarity of S-matrix

Bounds obtained for non-interacting 3-terminal transport
(K. Brandner, K. Saito, U. Seifert, PRL **110**, 070603 (2013))

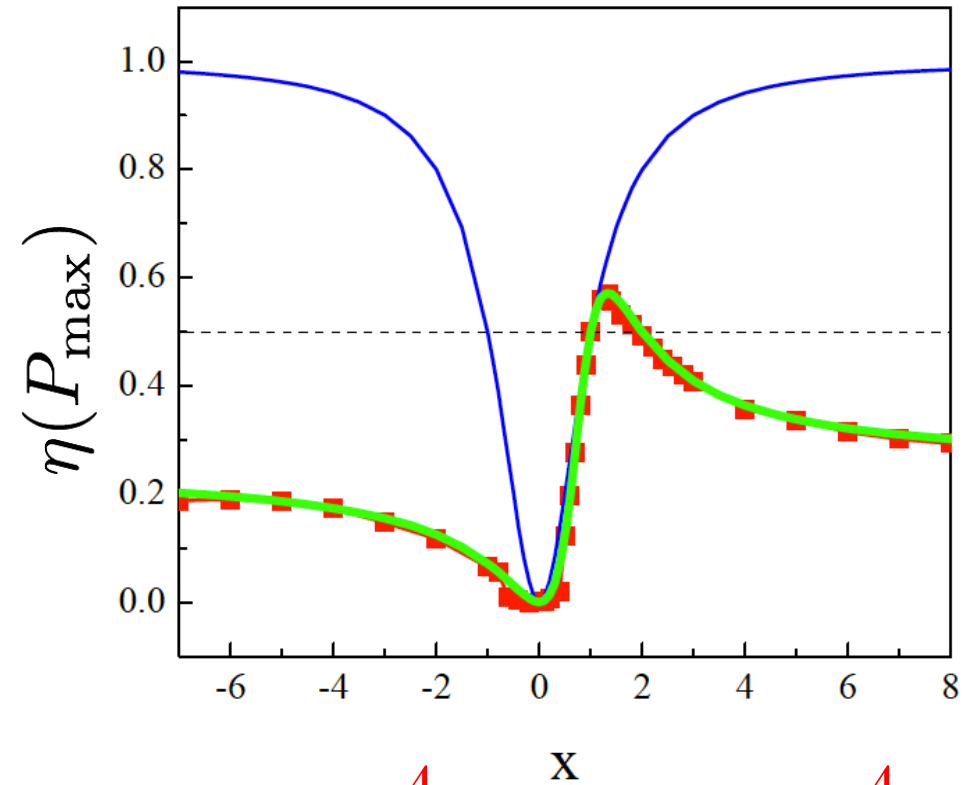
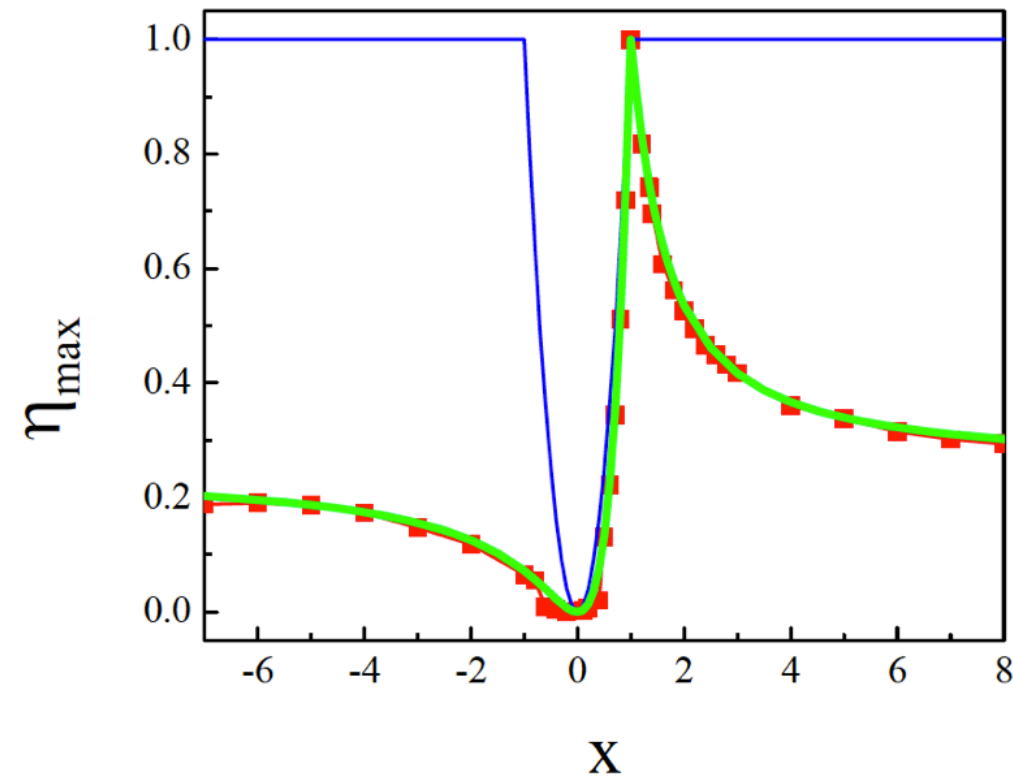

$$\eta(P_{\max}) = \frac{4}{7} \eta_C \quad \text{at} \quad x = \frac{4}{3}$$

Bounds for multi-terminal thermoelectricity

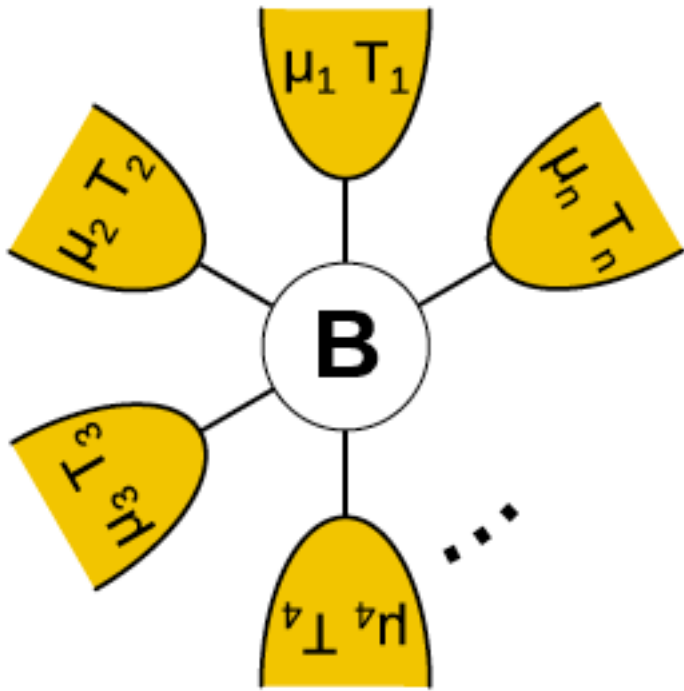

Numerical evidence that the power vanishes when the Carnot efficiency is approached

$n = 3, \dots, 12$ terminals

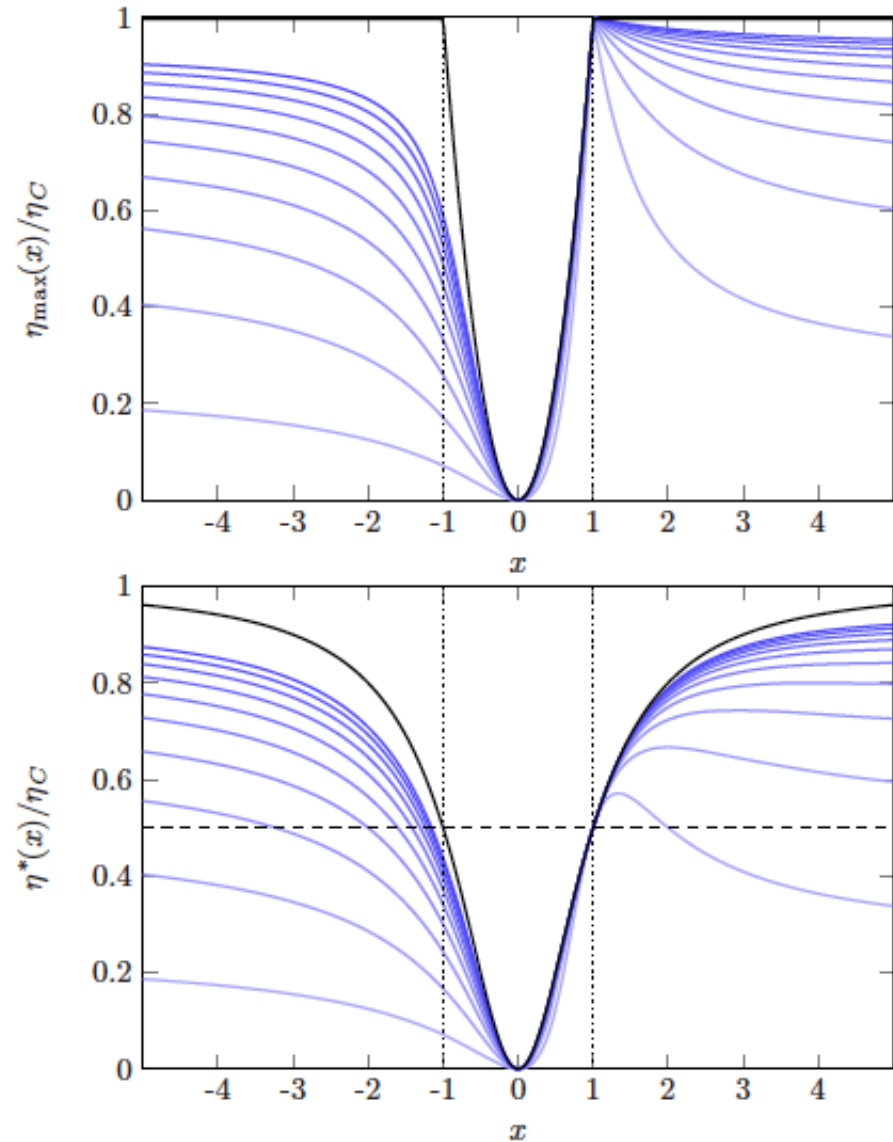

[Brandner and Seifert, NJP **15**, 105003 (2013); PRE **91**, 012121 (2015)]

Bounds with electron-phonon scattering

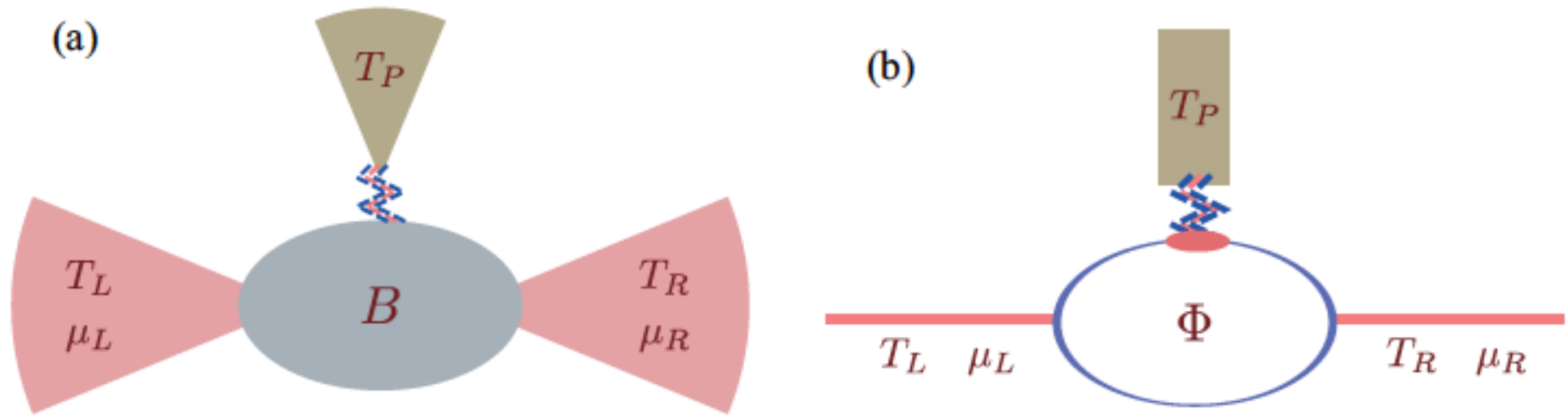

Efficiency bounded by the non-negativity of the entropy production of the original three-terminal junction. However, the efficiency at maximum power can be enhanced

[Yamamoto, Entin-Wohlman, Aharony, Hatano; PRB **94**, 121402(R) (2015)]

Onsager-Casimir relations

Onsager reciprocal relations reflect at the macroscopic level the time-reversal symmetry of the microscopic dynamics, invariant under the transformation:

$$\mathcal{T}(\mathbf{r}, \mathbf{p}, t) \equiv (\mathbf{r}, -\mathbf{p}, -t) \quad \Rightarrow \quad \dot{L}_{jk} = L_{kj}$$

With an applied magnetic field one instead obtains Onsager-Casimir relations:

$$\mathcal{T}_B(\mathbf{r}, \mathbf{p}, t, \mathbf{B}) \equiv (\mathbf{r}, -\mathbf{p}, -t, -\mathbf{B}) \quad \Rightarrow \quad L_{jk}(\mathbf{B}) = L_{kj}(-\mathbf{B})$$

but in principle one could

violate the Onsager symmetry: $L_{jk}(\mathbf{B}) \neq L_{kj}(\mathbf{B})$

Onsager relations and thermodynamic constraints on heat-to-work conversion

For thermoelectricity:

$$\Pi(\mathbf{B}) \neq TS(\bar{\mathbf{B}}) \text{ [that is, } L_{eh}(\mathbf{B}) \neq L_{he}(\mathbf{B})]$$

and in principle one could have the Carnot efficiency at finite power:

$$P = \frac{\eta_C}{4} \frac{|L_{eh}^2 - L_{he}^2|}{L_{ee}} \mathcal{F}_h$$

Onsager relations with broken time-reversal symmetry

Onsager relations under an applied magnetic field remain valid:

1) for **noninteracting systems**

2) if the magnetic field is **constant**

[Bonella, Ciccotti, Rondoni, EPL **108**, 60004 (2014)]

What about for a generic, spatially dependent magnetic field?

Symmetry without magnetic field inversion

$$H = \sum_i^N \frac{[\mathbf{p}_i - q_i \mathbf{A}(\mathbf{r}_i)]^2}{2m_i} + \frac{1}{2} \sum_{i \neq j} V(r_{ij})$$

Analytical result for $\mathbf{B} = B(x) \mathbf{k}$

Landau gauge: $A(x) \mathbf{j}$

$$\left\{ \begin{array}{l} \dot{x}_i = \frac{p_i^x}{m_i}, \\ \dot{y}_i = \frac{1}{m_i} [p_i^y - q_i A(x_i)], \\ \dot{z}_i = \frac{p_i^z}{m_i}, \\ \dot{p}_i^x = F_i^x + \frac{q_i}{m_i} [p_i^y - q_i A(x_i)] B(x_i), \\ \dot{p}_i^y = F_i^y, \\ \dot{p}_i^z = F_i^z, \end{array} \right. \quad \begin{array}{l} \text{Equations of motion} \\ \text{invariant under:} \\ \mathcal{M}(x, y, z, p^x, p^y, p^z, t, \mathbf{B}) \\ \equiv (x, -y, z, -p^x, p^y, -p^z, -t, \mathbf{B}) \end{array}$$

$$F_i^\alpha = -\frac{\partial \sum_{j \neq i} V(r_{ij})}{\partial \alpha}$$

Numerical results

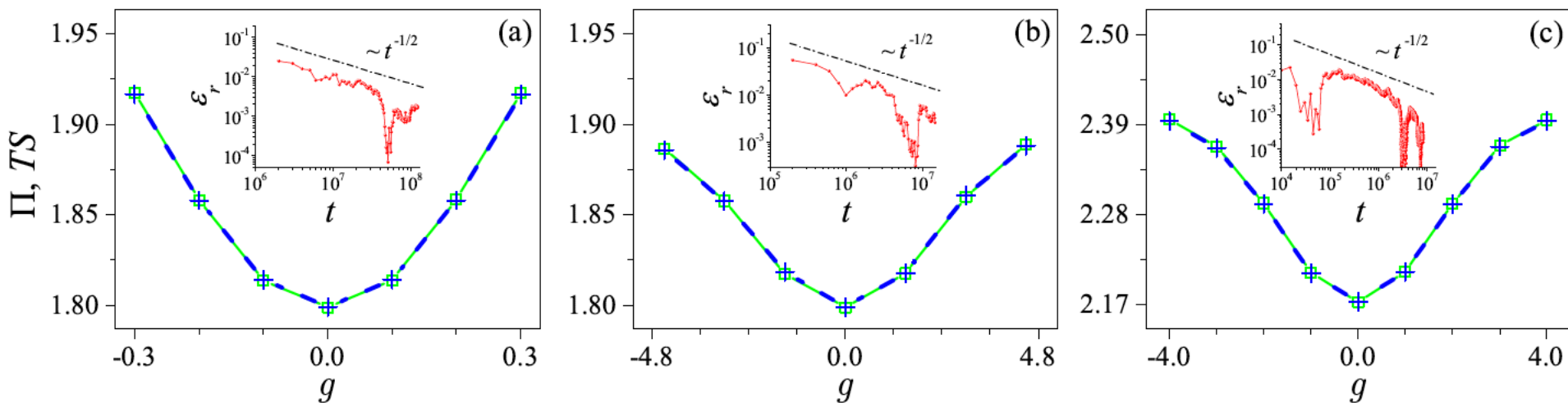

$$B(x) = gx$$

generic 2D case:

$$B(x, y) = g \sin[\pi x/(2L)] \sin[\pi y/(2W)]$$

generic 3D case:

$$\mathbf{B} = g(B_x, B_y, B_z),$$

$$B_x = f_y f_z, B_y = f_z f_x, B_z = f_x f_y,$$

$$f_x = \sin[\pi x/(2L)], f_y = \sin[\pi y/(2W)],$$

$$f_z = \sin[\pi z/(2H)]$$

Theoretical argument:
divide the system into small
volumes dV_α

Time-reversal trajectories without
reversing the field for $dV_\alpha \rightarrow 0$

No-go theorem for finite power at the Carnot efficiency on purely thermodynamic grounds?

According to Nico Van Kampen Onsager derived his reciprocal relations in a “*stroke of genius*”

Onsager reciprocal relations (or the **fourth law of thermodynamics**) much more general than expected so far.

Quantum computation and information is a rapidly developing interdisciplinary field. It is not easy to understand its fundamental concepts and central results without facing numerous technical details. This book provides the reader with a useful guide. In particular, the initial chapters offer a simple and self-contained introduction; no previous knowledge of quantum mechanics or classical computation is required.

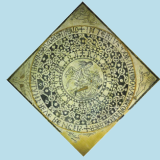

Various important aspects of quantum computation and information are covered in depth, starting from the foundations (the basic concepts of computational complexity, energy, entropy, and information, quantum superposition and entanglement, elementary quantum gates, the main quantum algorithms, quantum teleportation, and

quantum cryptography) up to advanced topics (like entanglement measures, quantum discord, quantum noise, quantum channels, quantum error correction, quantum simulators, and tensor networks).

It can be used as a broad range textbook for a course in quantum information and computation, both for upper-level undergraduate students and for graduate students. It contains a large number of solved exercises, which are an essential complement to the text, as they will help the student to become familiar with the subject. The book may also be useful as general education for readers who want to know the fundamental principles of quantum information and computation.

“Thorough introductions to classical computation and irreversibility, and a primer of quantum theory, lead into the heart of this impressive and substantial book. All the topics – quantum algorithms, quantum error correction, adiabatic quantum computing and decoherence are just a few – are explained carefully and in detail. Particularly attractive are the connections between the conceptual structures and mathematical formalisms, and the different experimental protocols for bringing them to practice. A more wide-ranging, comprehensive, and definitive text is hard to imagine.”

— Sir Michael Berry, *University of Bristol, UK*

“This second edition of the textbook is a timely and very comprehensive update in a rapidly developing field, both in theory as well as in the experimental implementation of quantum information processing. The book provides a solid introduction into the field, a deeper insight in the formal description of quantum information as well as a well laid-out overview on several platforms for quantum simulation and quantum computation. All in all, a well-written and commendable textbook, which will prove very valuable both for the novices and the scholars in the fields of quantum computation and information.”

— Rainer Blatt, *Universität Innsbruck and IQOQI Innsbruck, Austria*

“The book by Benenti, Casati, Rossini and Strini is an excellent introduction to the fascinating field of quantum information, of great benefit for scientists entering the field and a very useful reference for people already working in it. The second edition of the book is considerably extended with new chapters, as the one on many-body systems, and necessary updates, most notably on the physical implementations.”

— Rosario Fazio, *The Abdus Salam International Centre for Theoretical Physics, Trieste, Italy*

Benenti
Casati
Rossini
Strini

Principles of Quantum Computation and Information
A Comprehensive Textbook

Giuliano Benenti Giulio Casati
Davide Rossini Giuliano Strini



Principles of Quantum Computation
and Information
A Comprehensive Textbook

World Scientific
www.worldscientific.com
10909 hc



World Scientific